

Applicable Model

S535

Drawing Title

Intercom Panel

Drawing Unit

mm

Drawing Scale

Not to scale

**DRAFT
SUBJECT TO
CHANGE**

Last Revised

Nov 26, 2025

Drawing Version

V1.1

Page

1 of 20

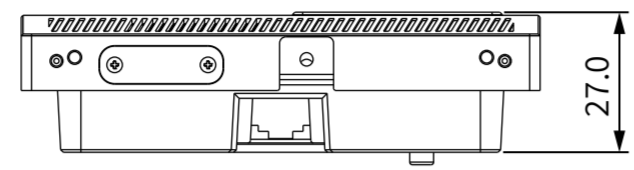

⑥ BOTTOM VIEW

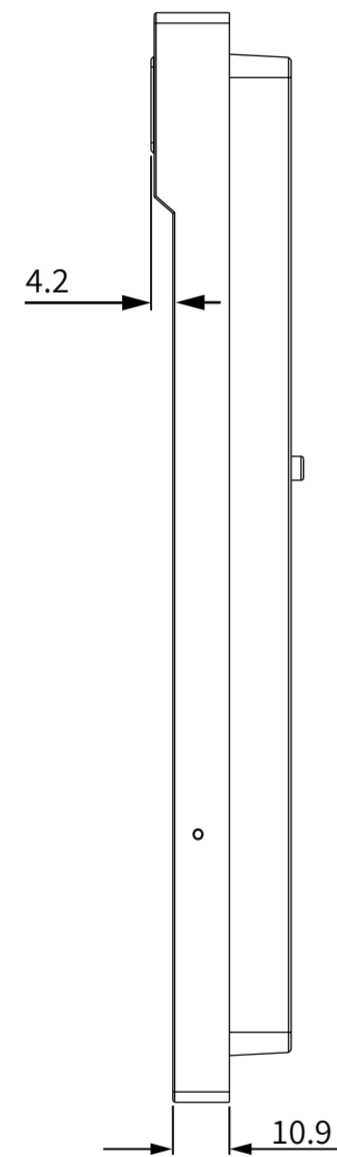

② RIGHT VIEW

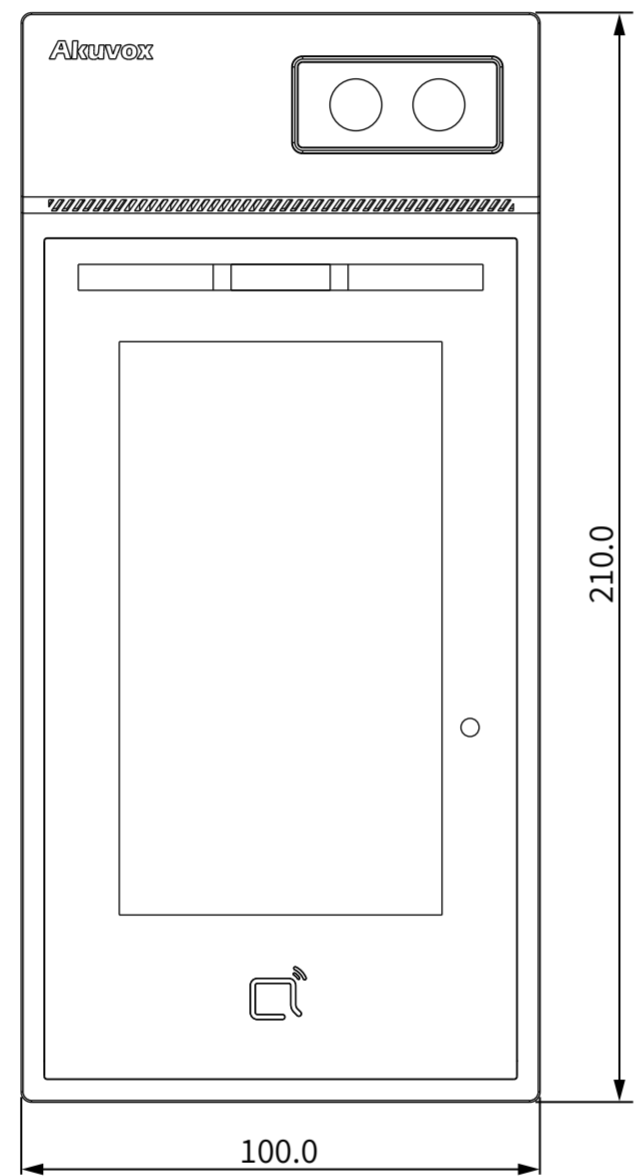

① FRONT VIEW

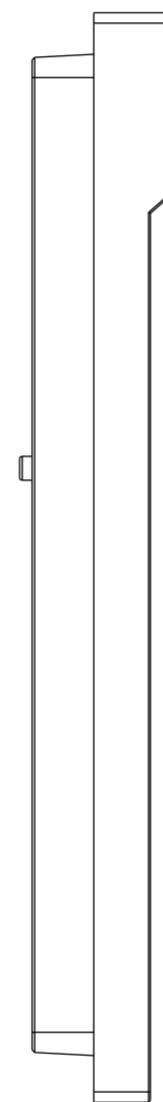

③ LEFT VIEW

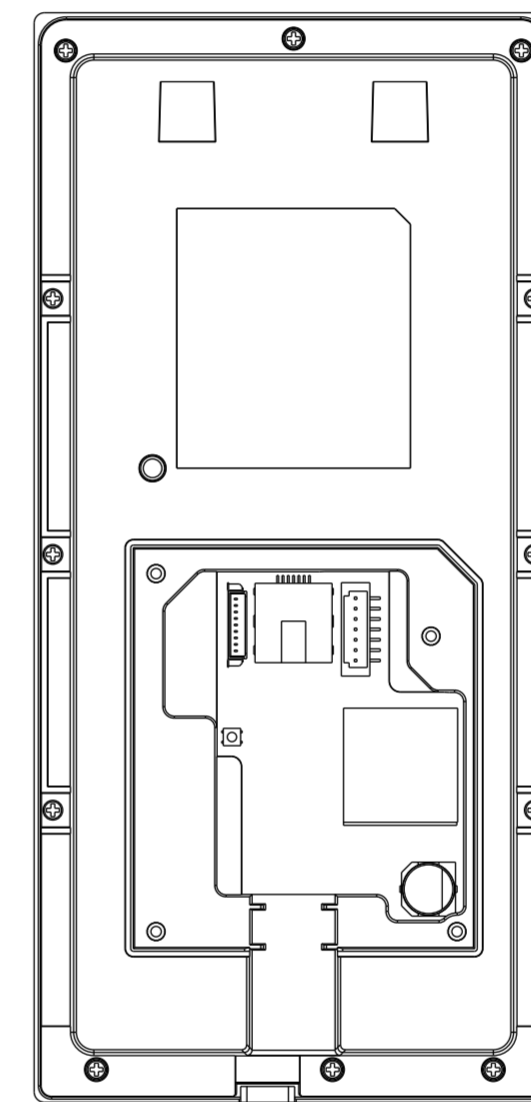

④ BACK VIEW

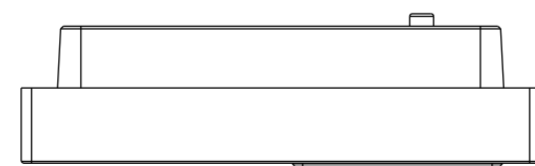

⑤ TOP VIEW

Applicable Model

S535

Drawing Title

Wall Mounting
Box

Drawing Unit

mm

Drawing Scale

Not to scale

**DRAFT
SUBJECT TO
CHANGE**

Last Revised

Nov 26, 2025

Drawing Version

V1.1

Page

2 of 20

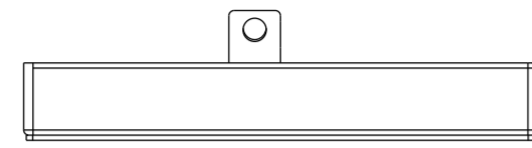

⑥ **BOTTOM VIEW**



② **RIGHT VIEW**

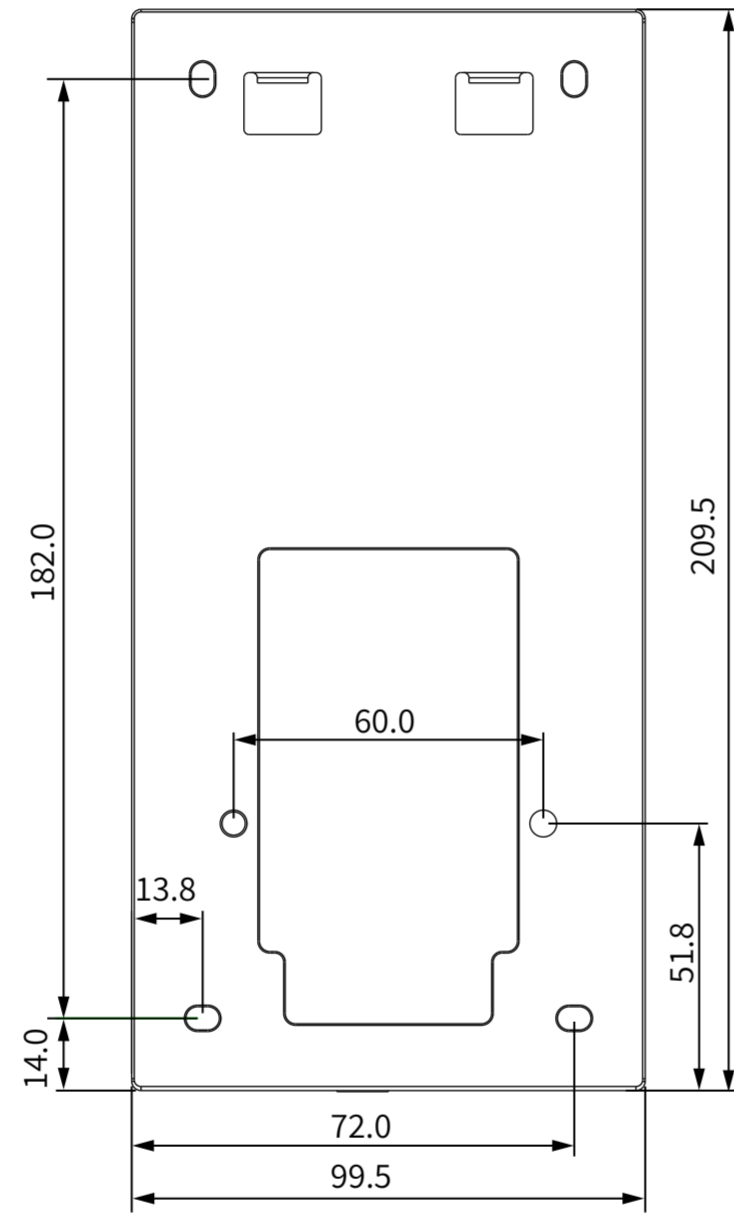

① **FRONT VIEW**

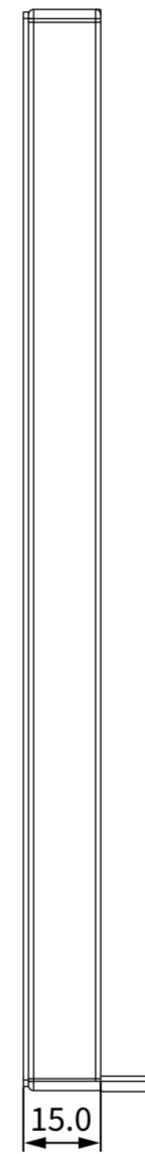

③ **LEFT VIEW**

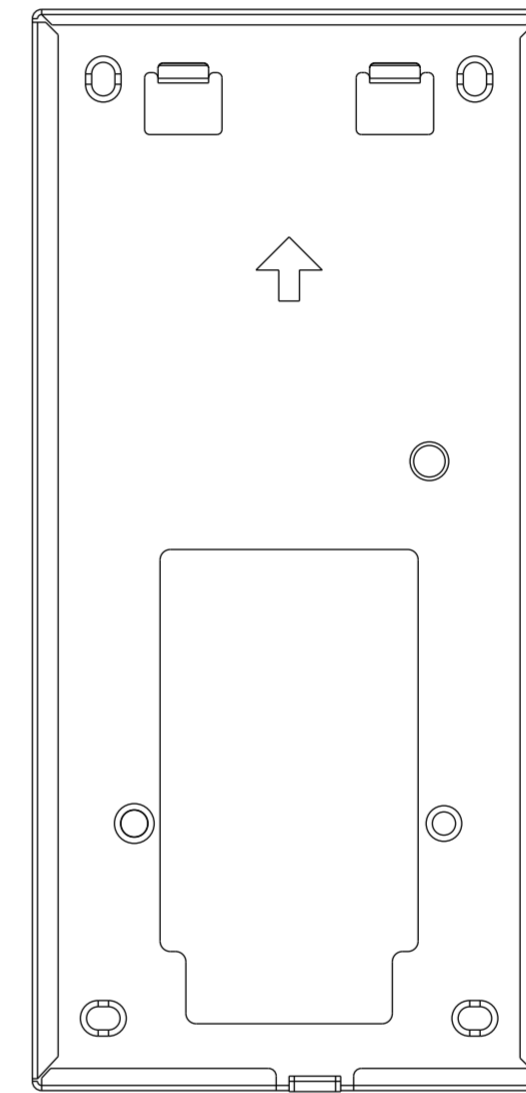

④ **BACK VIEW**

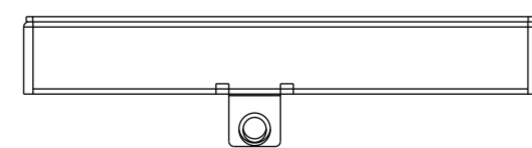

⑤ **TOP VIEW**

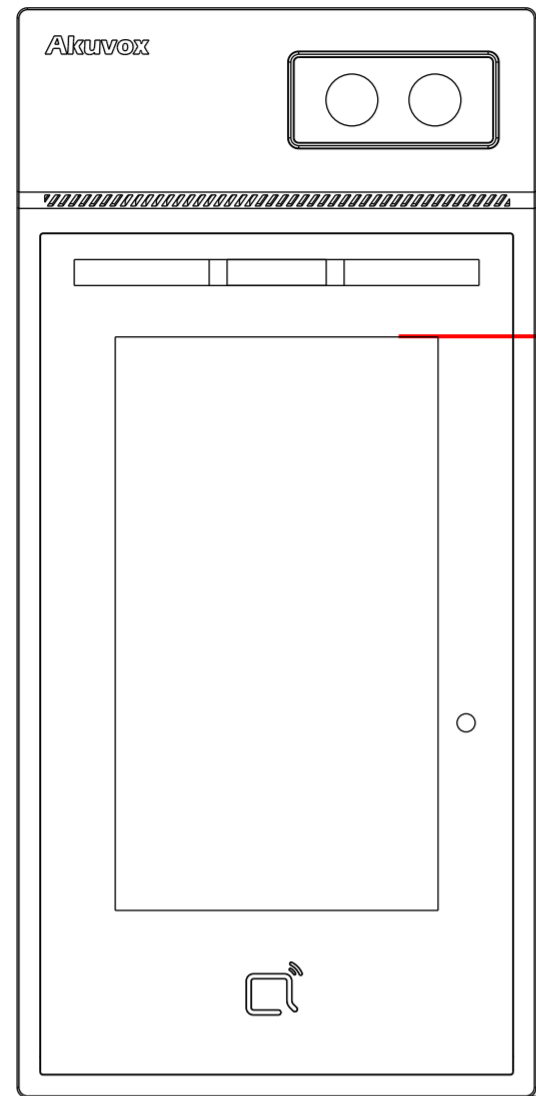

① INTERCOM PANEL FRONT VIEW

42.2 inch TO BOTTOM OF PANEL

48.0 inch TO CENTER OF CAMERA

ADA Compliance Requirement

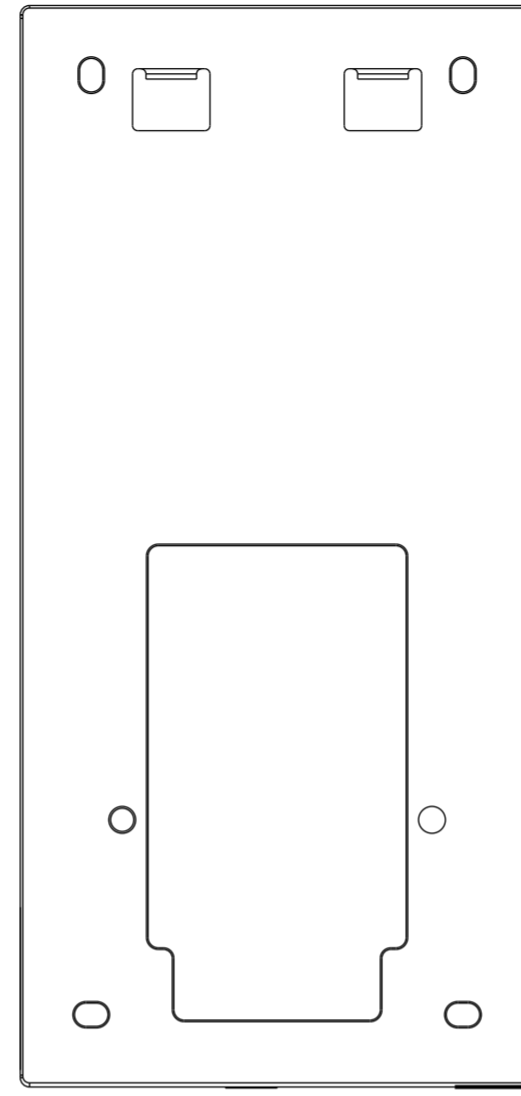
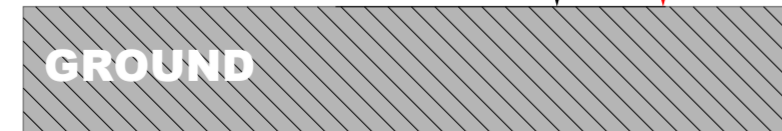

② FRONT VIEW:WALL MOUNTING BOX PLACEMENT

42.2 inch TO BOTTOM OF BRACKET

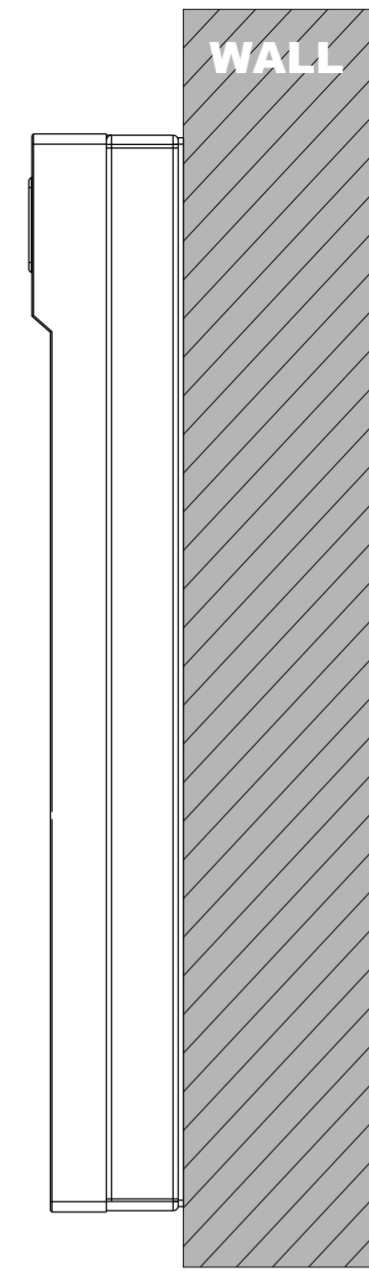

③ SIDE VIEW:INTERCOM ON WALL

Applicable Model

S535

Drawing Title

Flushing Mounting
Bracket

Drawing Unit

mm

Drawing Scale

Not to scale

**DRAFT
SUBJECT TO
CHANGE**

Last Revised

Nov 26, 2025

Drawing Version

V1.1

Page

4 of 20

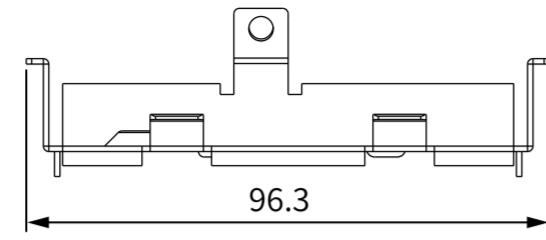

⑥ BOTTOM VIEW

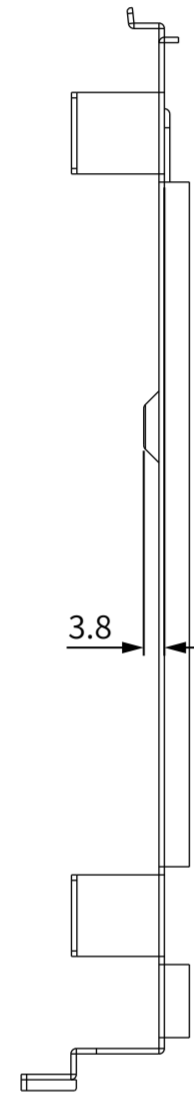

② RIGHT VIEW

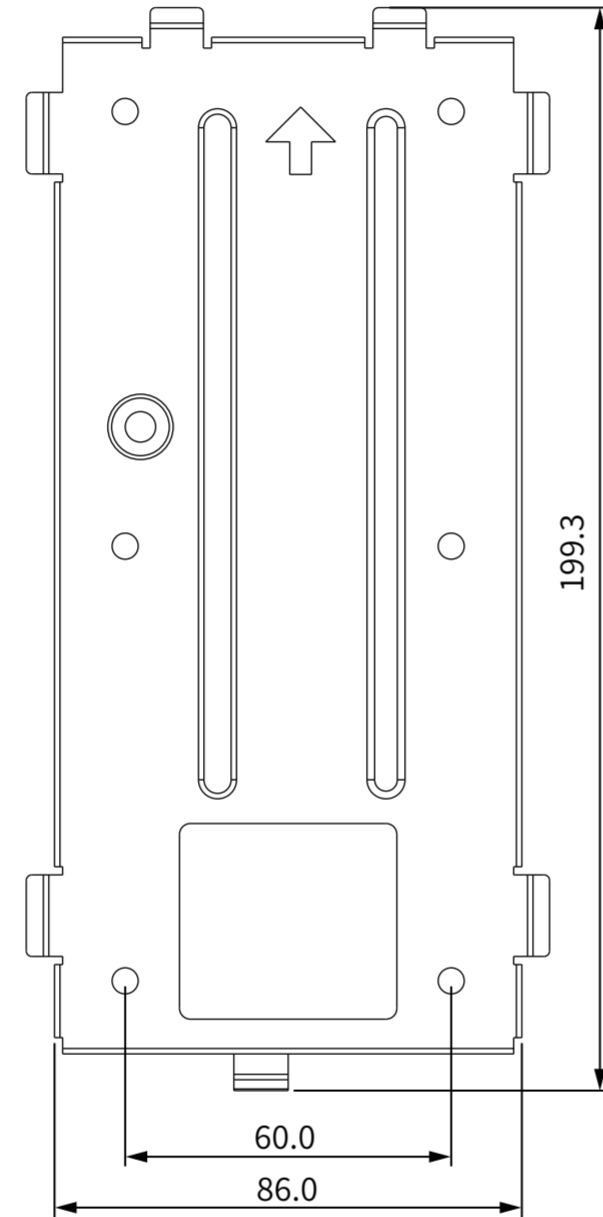

① FRONT VIEW

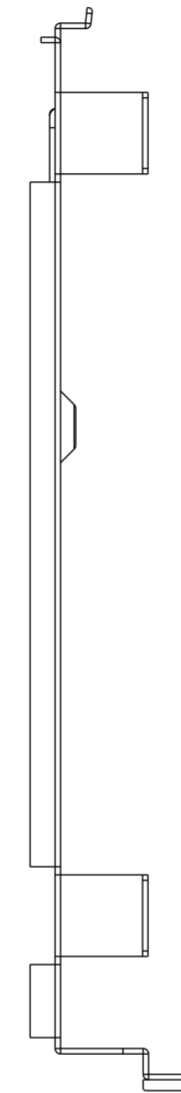

③ LEFT VIEW

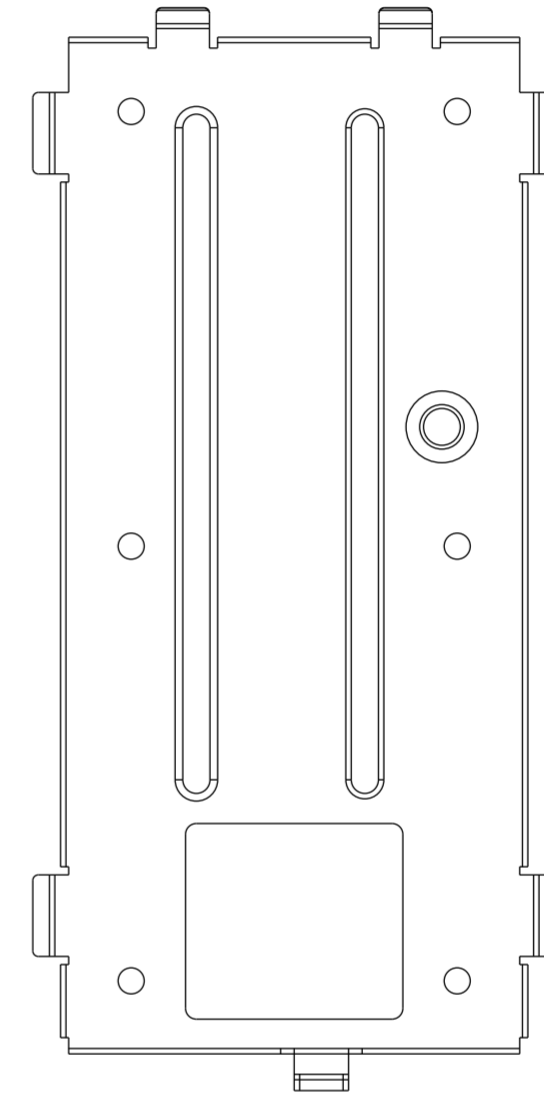

④ BACK VIEW

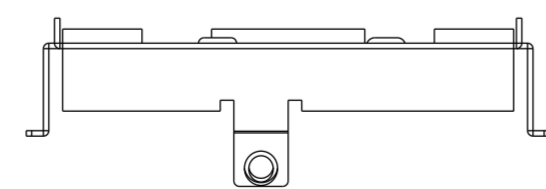

⑤ TOP VIEW

Applicable Model

S535

Drawing Title

Flushing
Mounting Box

Drawing Unit

mm

Drawing Scale

Not to scale

**DRAFT
SUBJECT TO
CHANGE**

Last Revised

Nov 26,2025

Drawing Version

V1.1

Page

5 of 20

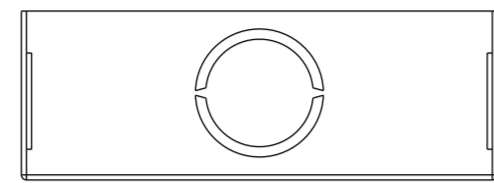

⑥ BOTTOM VIEW

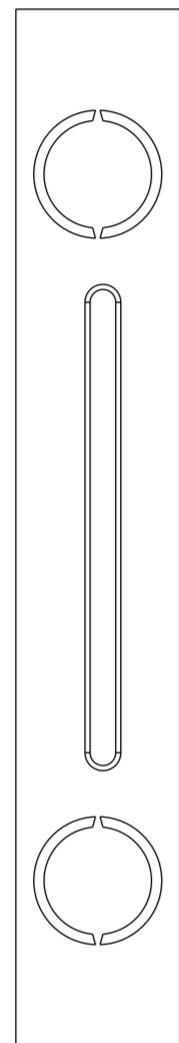

② RIGHT VIEW

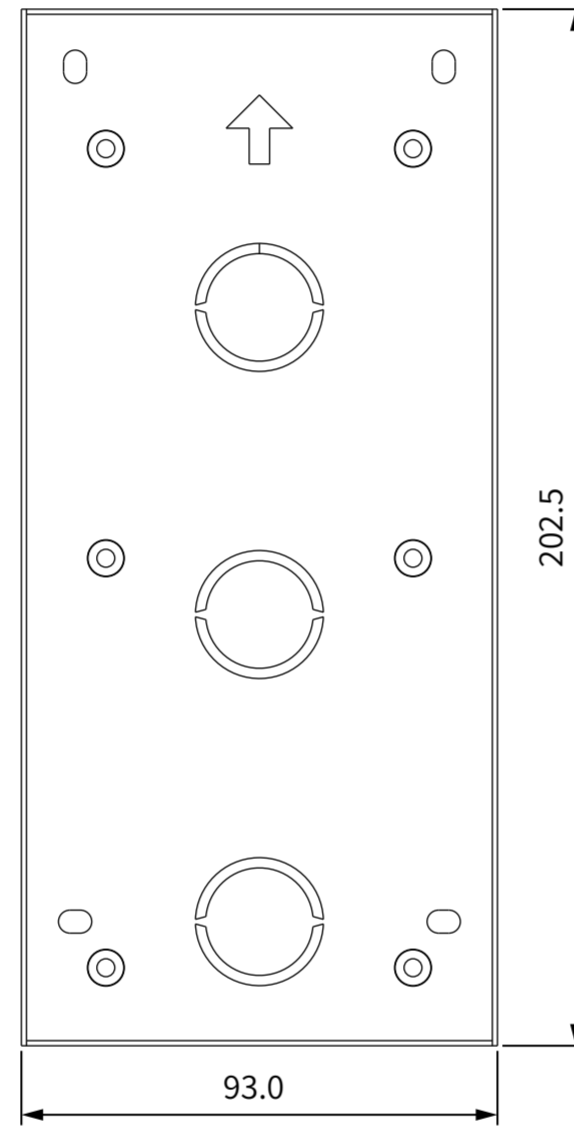

① FRONT VIEW

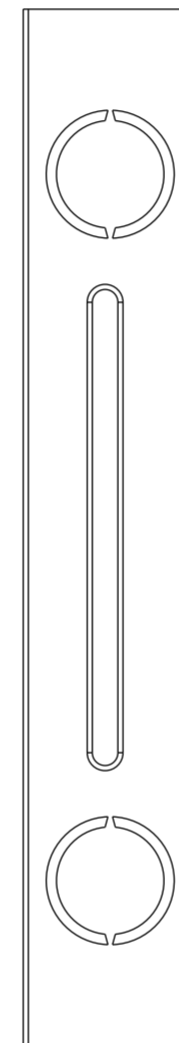

③ LEFT VIEW

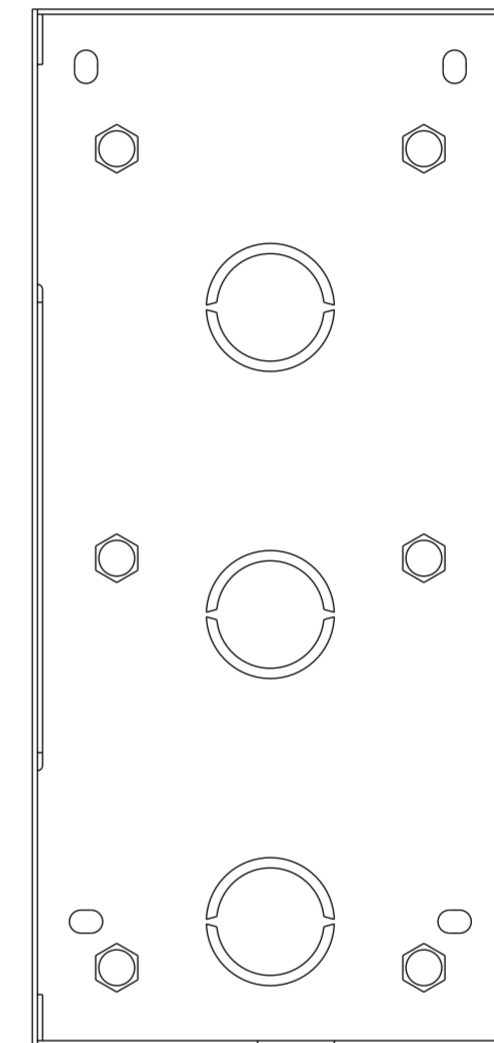

④ BACK VIEW

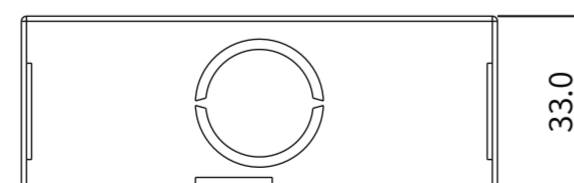

⑤ TOP VIEW

Applicable Model
S535

Drawing Title
Placement

Drawing Unit
mm

Drawing Scale
Not to scale

**DRAFT
SUBJECT TO
CHANGE**

Last Revised
Nov 26,2025

Drawing Version
V1.1

Page
6 of 20

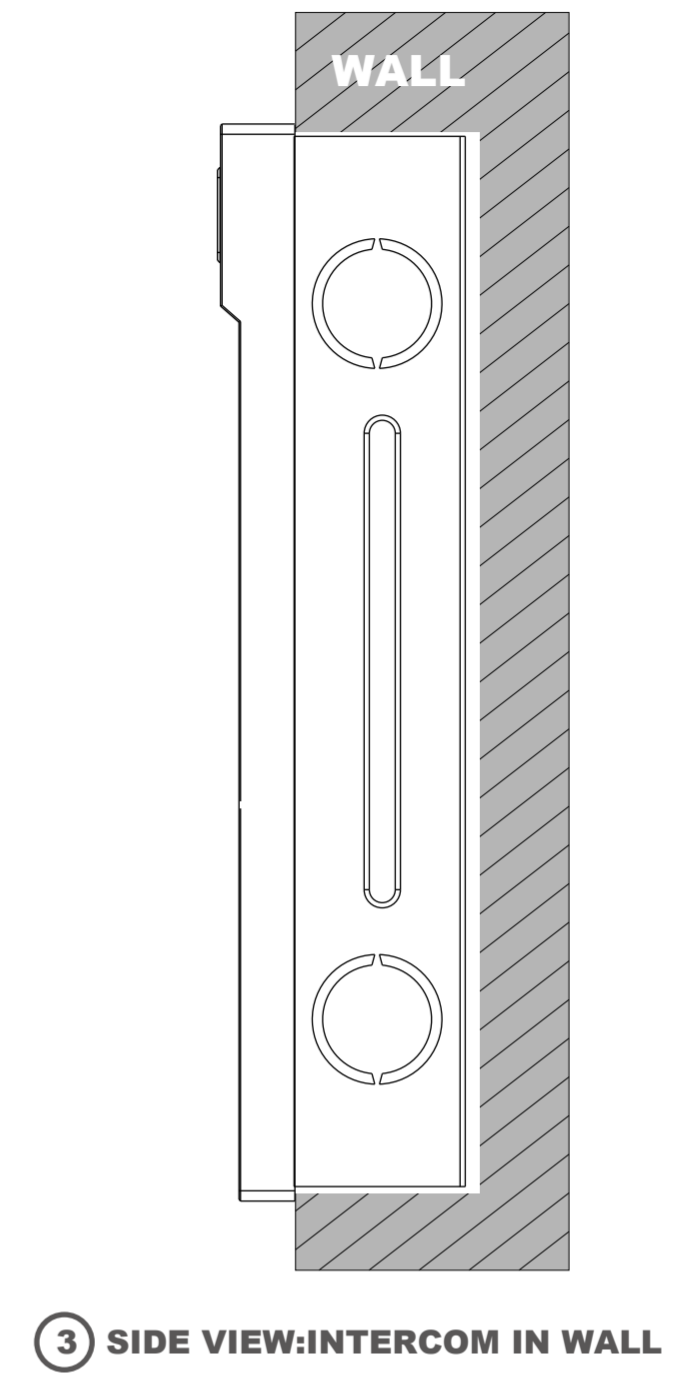
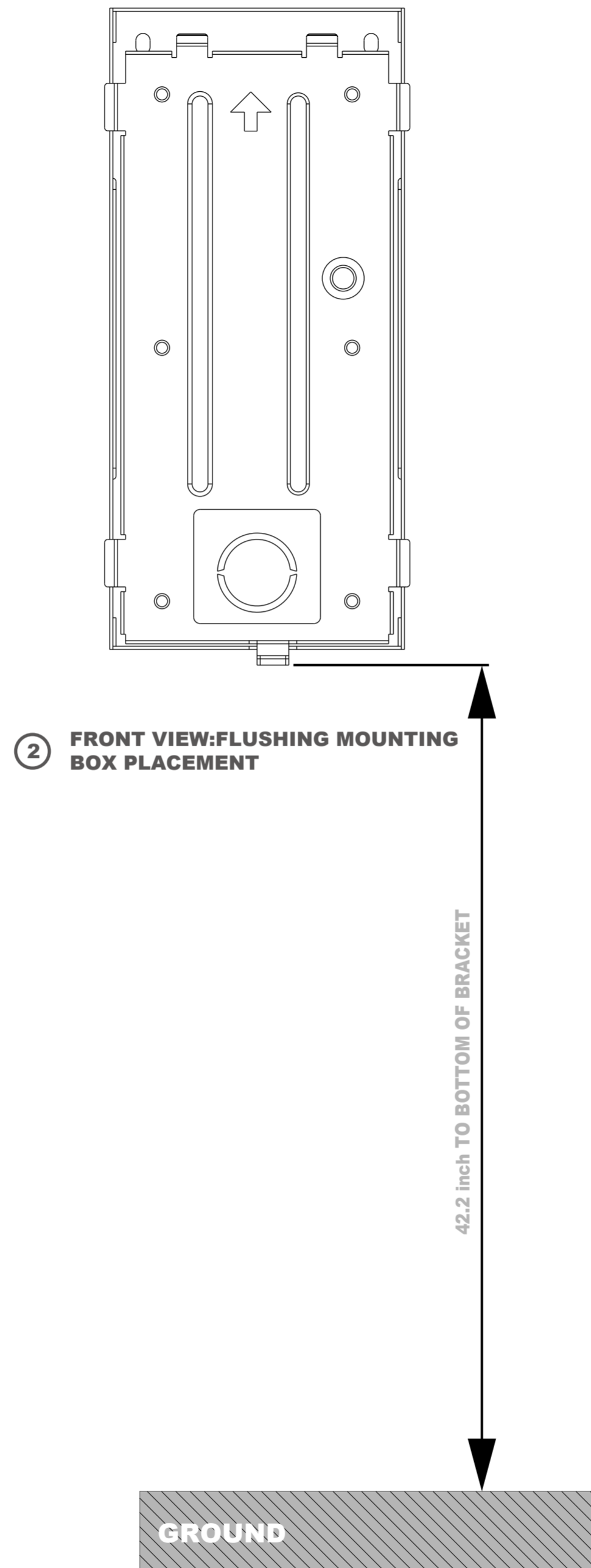
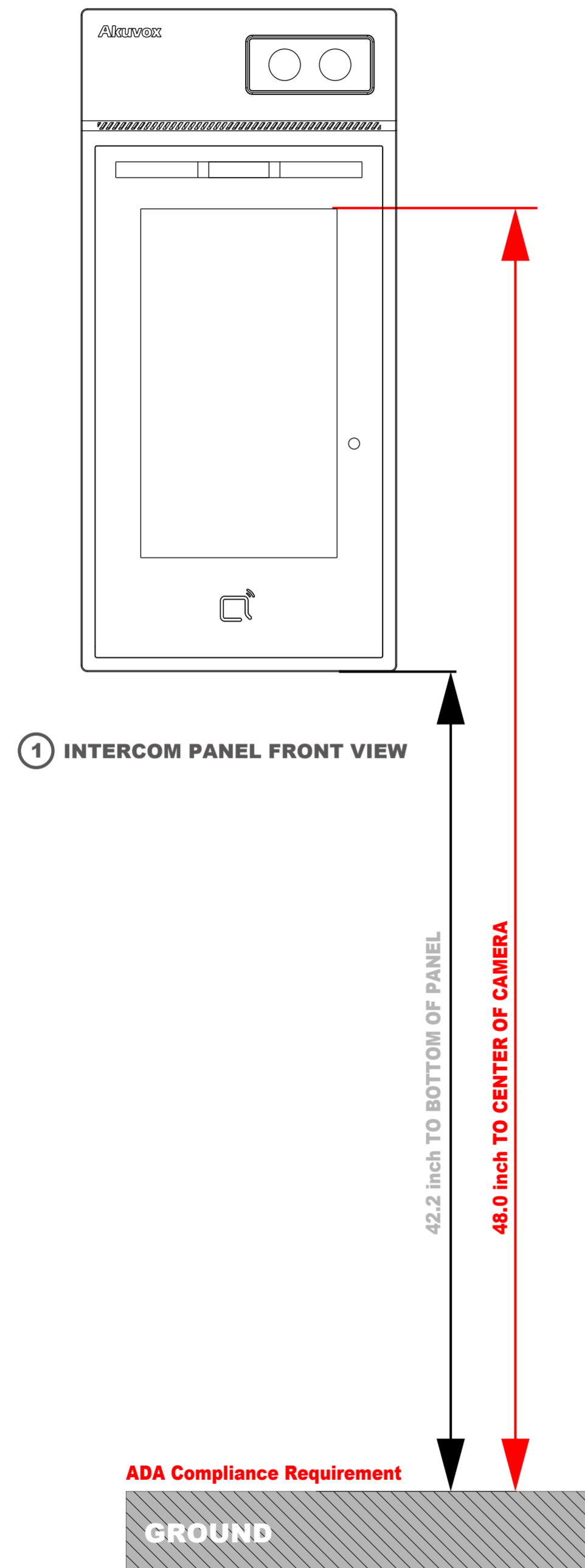

Applicable Model

S535

Drawing Title

In-Wall Mounting
Rain Cover

Drawing Unit

mm

Drawing Scale

Not to scale

**DRAFT
SUBJECT TO
CHANGE**

Last Revised

Nov 26, 2025

Drawing Version

V1.1

Page

7 of 20

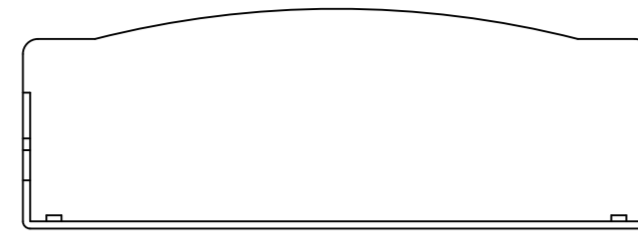

⑥ BOTTOM VIEW

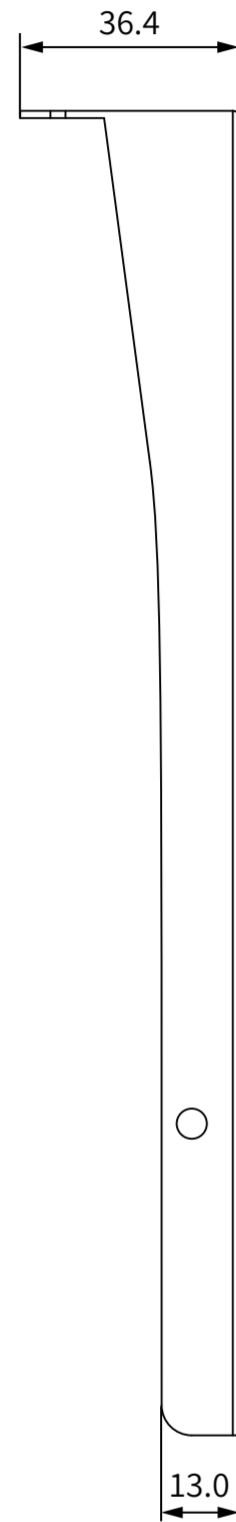

② RIGHT VIEW

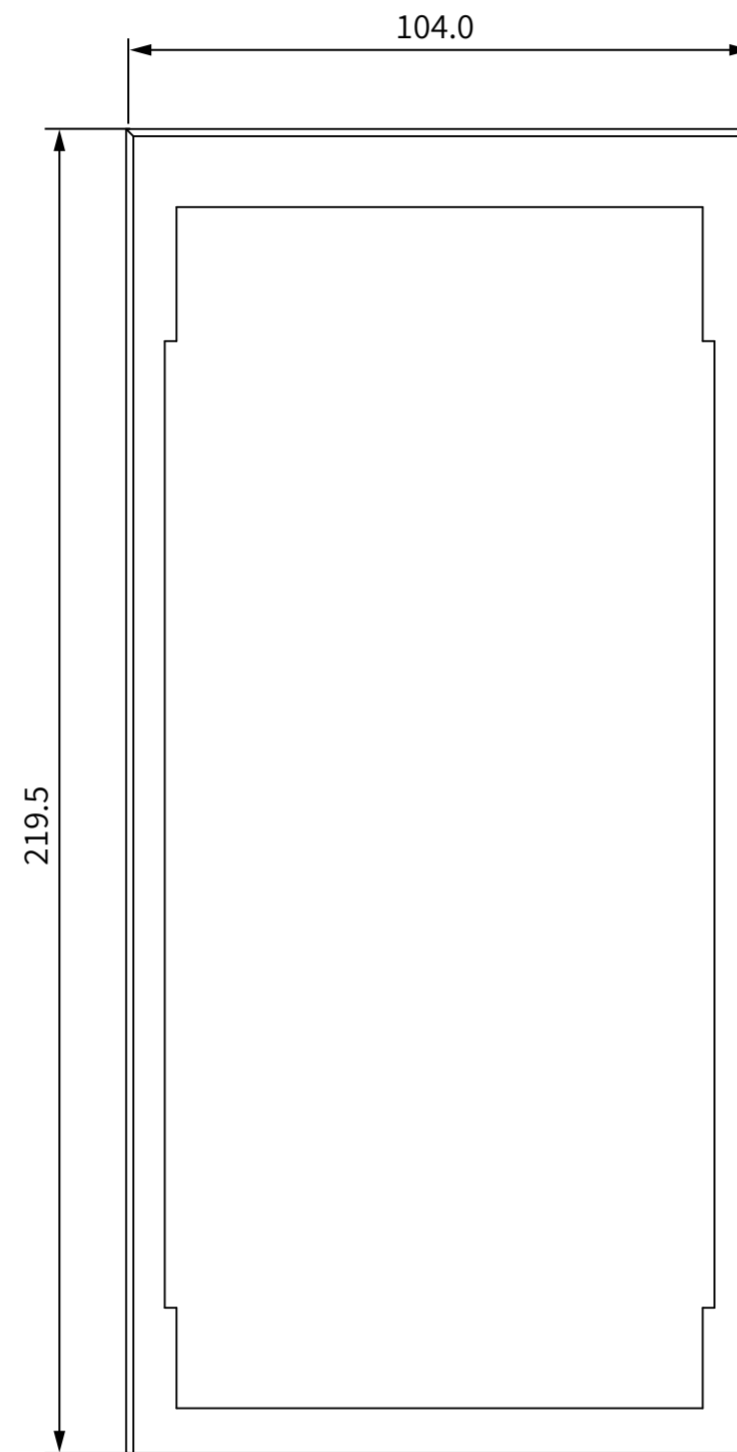

① FRONT VIEW

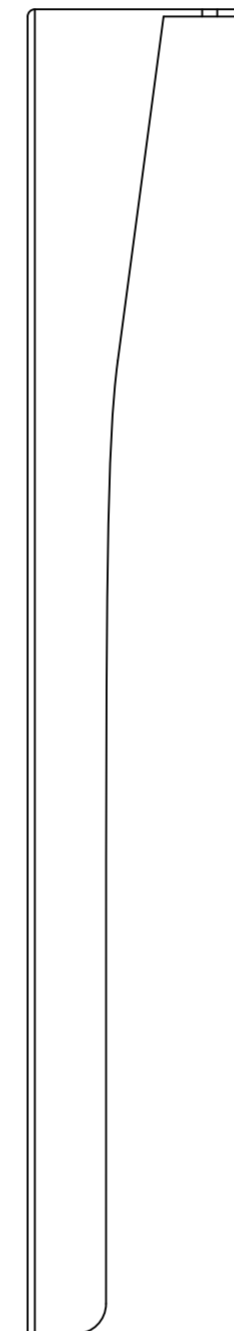

③ LEFT VIEW

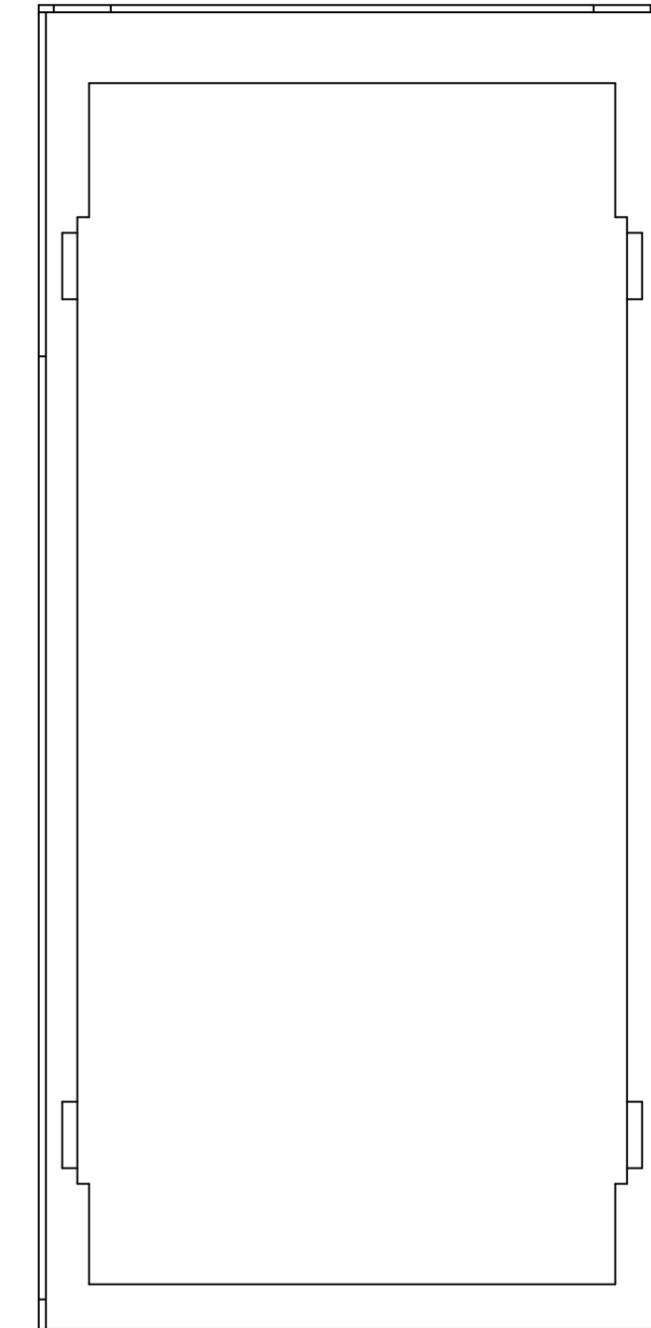

④ BACK VIEW

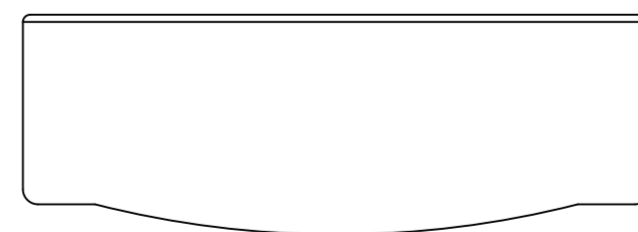

⑤ TOP VIEW

Applicable Model

S535

Drawing Title

Placement

Drawing Unit

mm

Drawing Scale

Not to scale

**DRAFT
SUBJECT TO
CHANGE**

Last Revised

Nov 26, 2025

Drawing Version

V1.1

Page

8 of 20

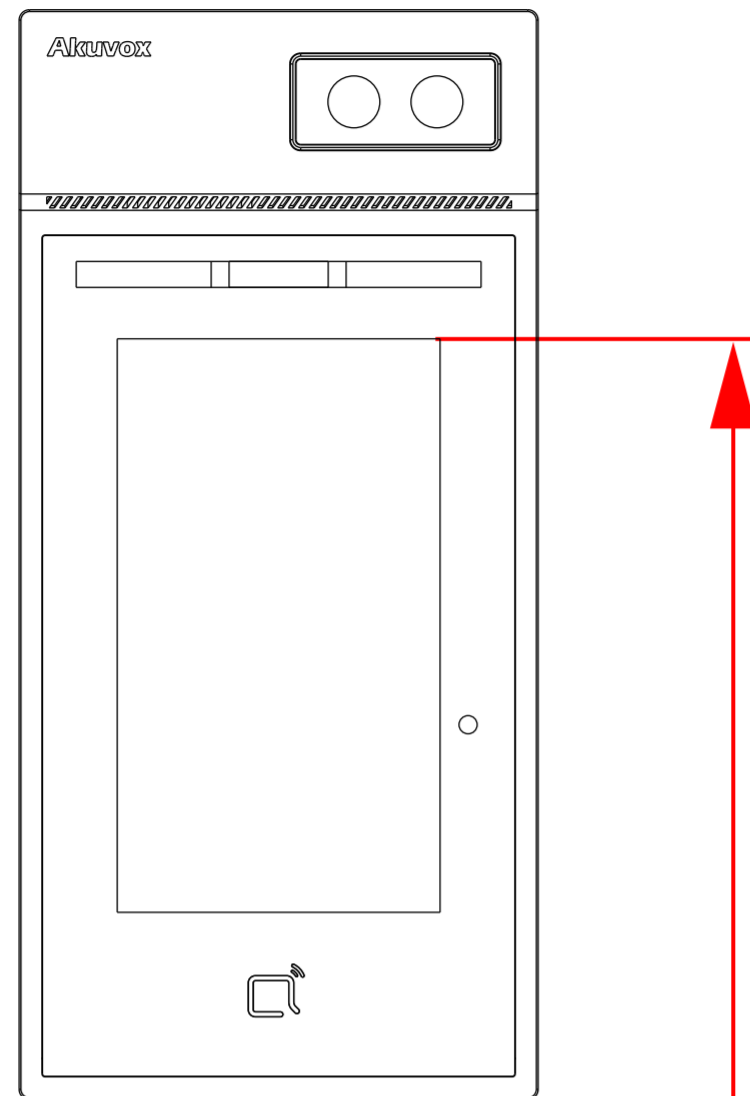

① INTERCOM PANEL FRONT VIEW

42.2 inch TO BOTTOM OF PANEL

48.0 inch TO CENTER OF CAMERA

ADA Compliance Requirement

GROUND

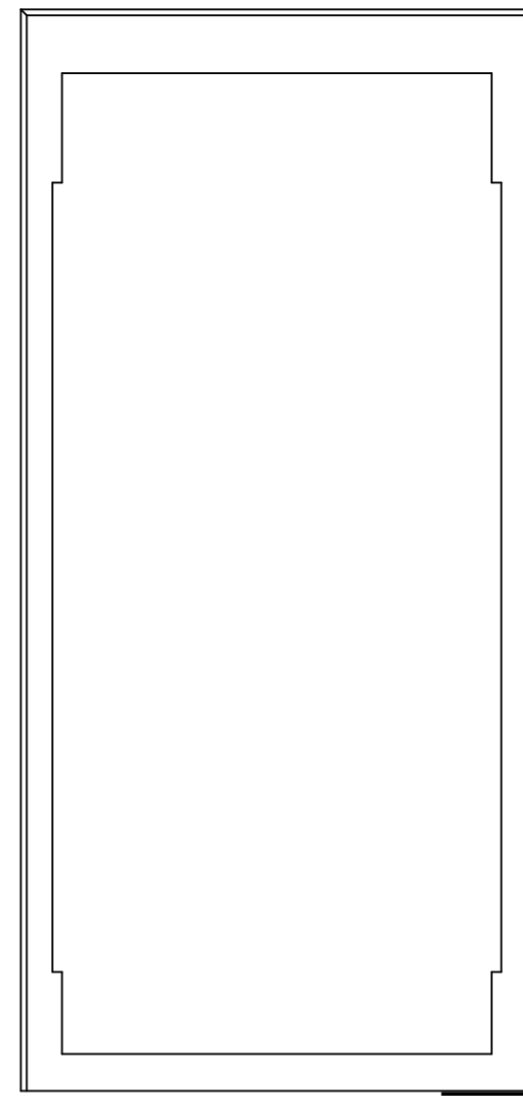

② FRONT VIEW:IN-WALL MOUNTING
RAIN COVER PLACEMENT

42.2 inch TO BOTTOM OF BRACKET

GROUND

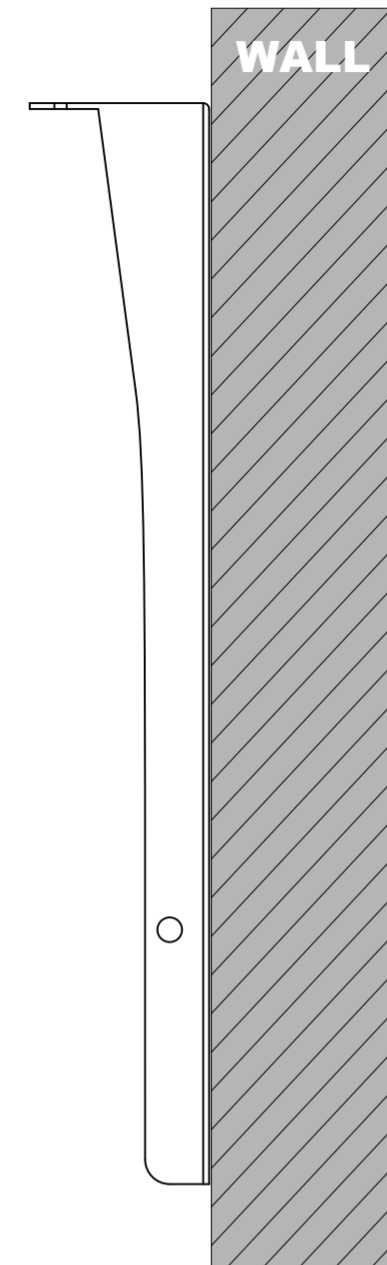

③ SIDE VIEW:INTERCOM IN WALL

Applicable Model

S535

Drawing Title

On-Wall Mountin
Rain Cover

Drawing Unit

mm

Drawing Scale

Not to scale

**DRAFT
SUBJECT TO
CHANGE**

Last Revised

Nov 26, 2025

Drawing Version

V1.1

Page

9 of 20

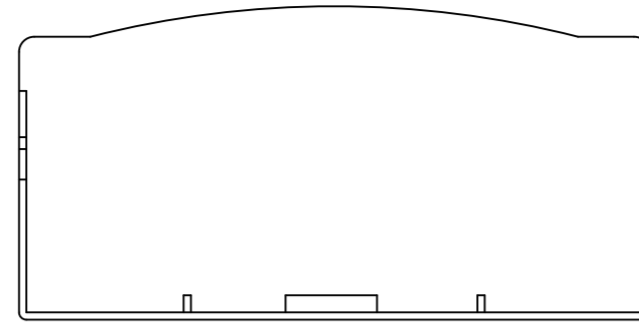

⑥ BOTTOM VIEW

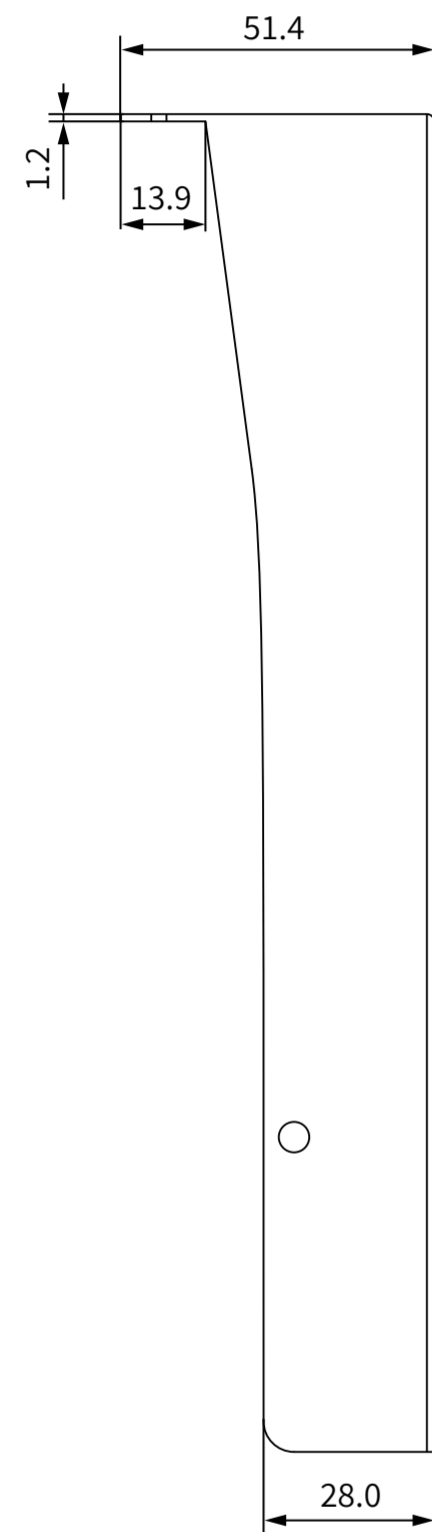

② RIGHT VIEW

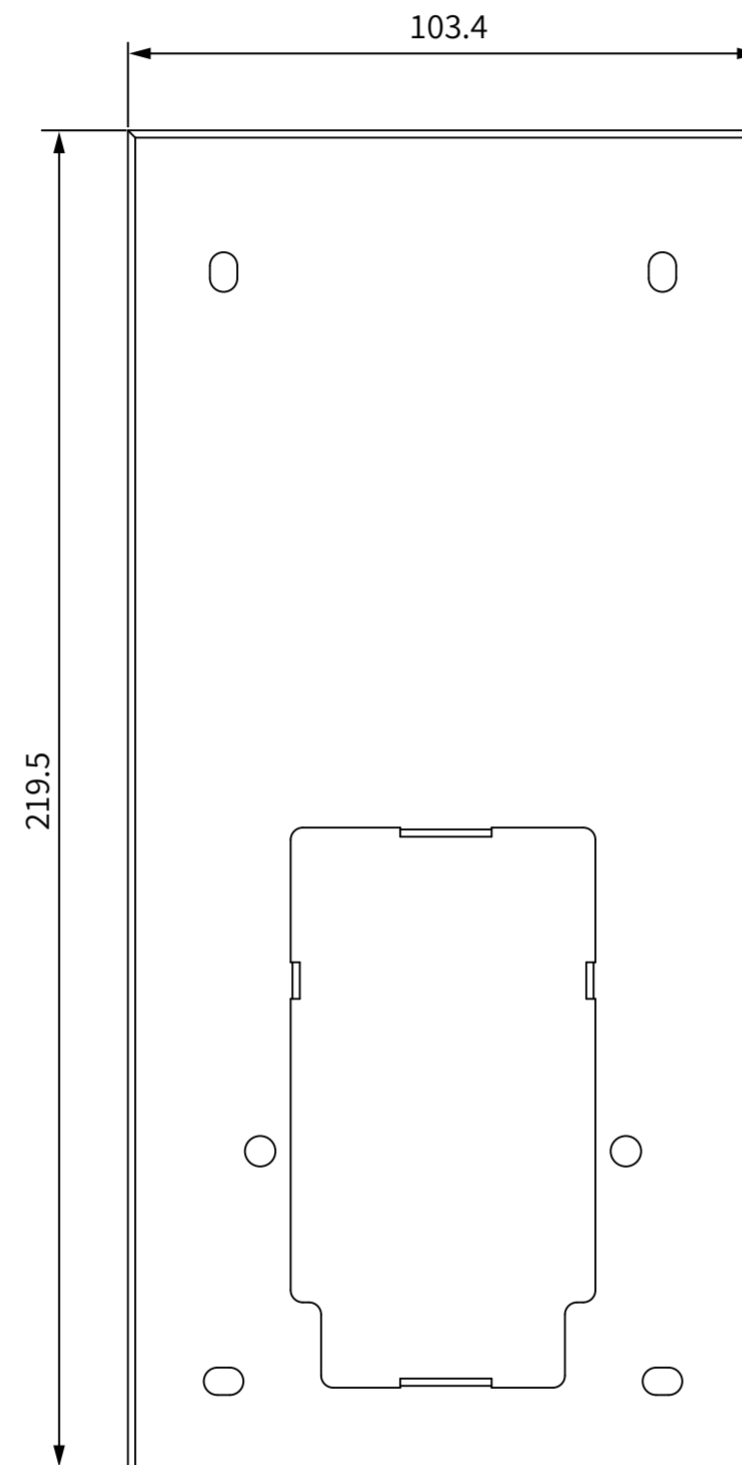

① FRONT VIEW

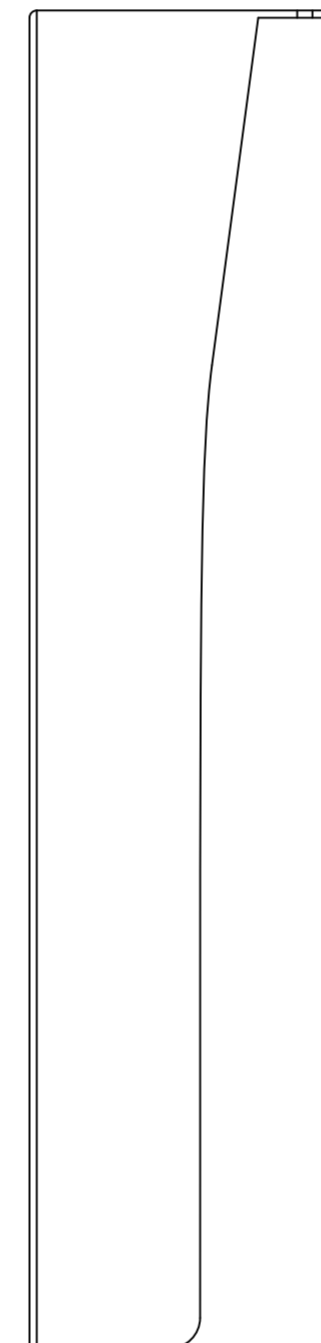

③ LEFT VIEW

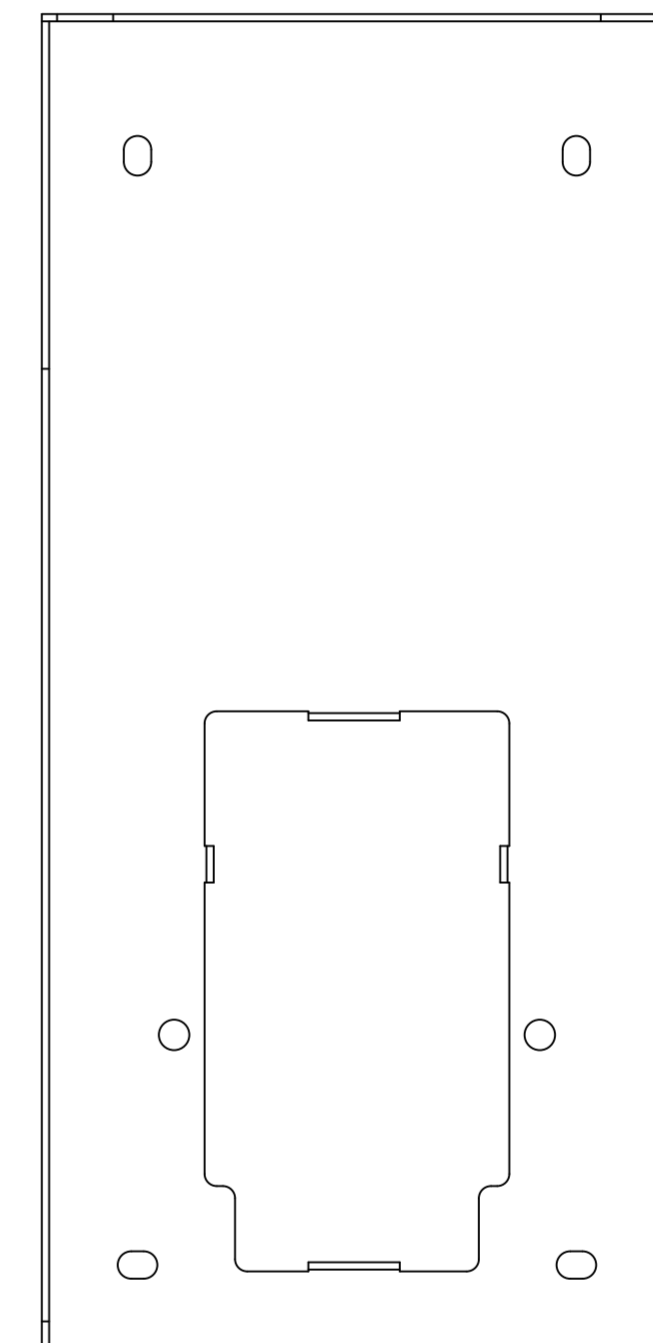

④ BACK VIEW

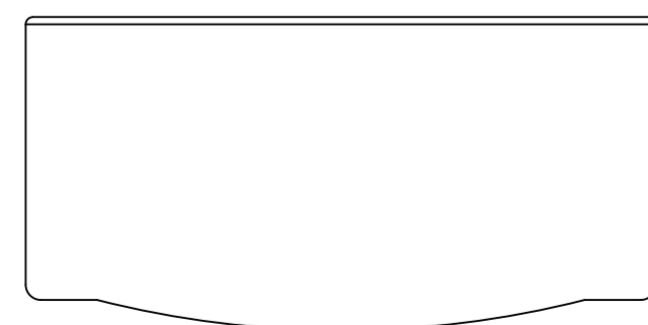

⑤ TOP VIEW

Applicable Model

S535

Drawing Title

Placement

Drawing Unit

mm

Drawing Scale

Not to scale

**DRAFT
SUBJECT TO
CHANGE**

Last Revised

Nov 26 2025

Drawing Version

V1.1

Page

10 of 20

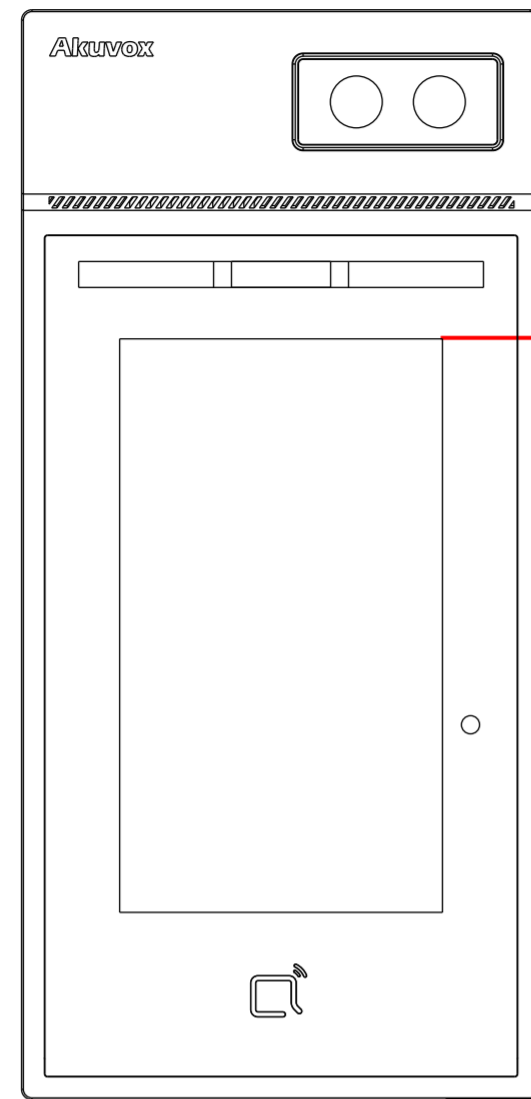

① INTERCOM PANEL FRONT VIEW

42.2 inch TO BOTTOM OF PANEL

48.0 inch TO CENTER OF CAMERA

ADA Compliance Requirement

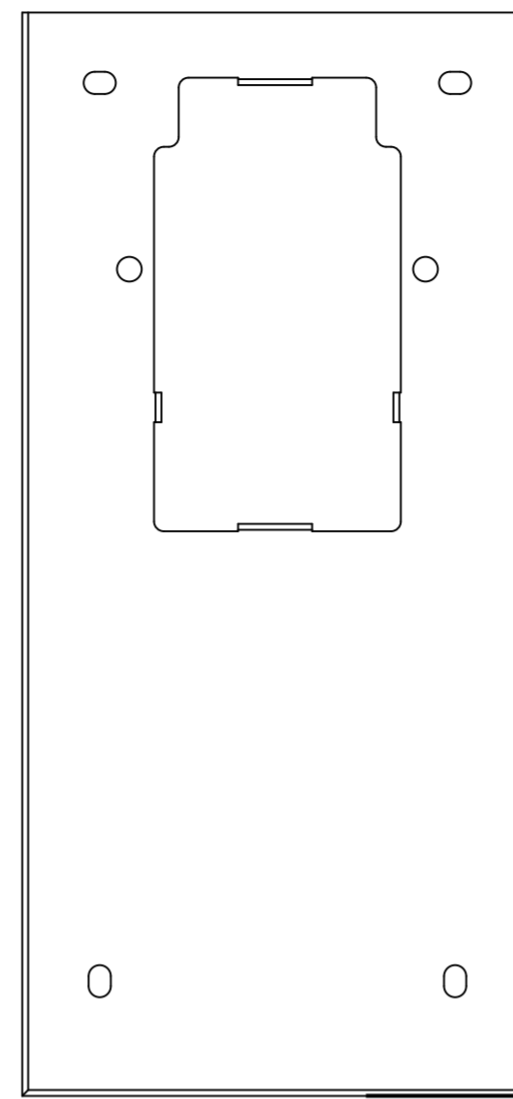
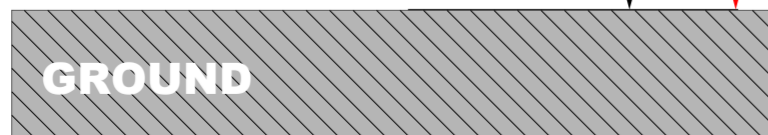

② FRONT VIEW:ON-WALL MOUNTIN
RAIN COVER PLACEMENT

42.2 inch TO BOTTOM OF BRACKET

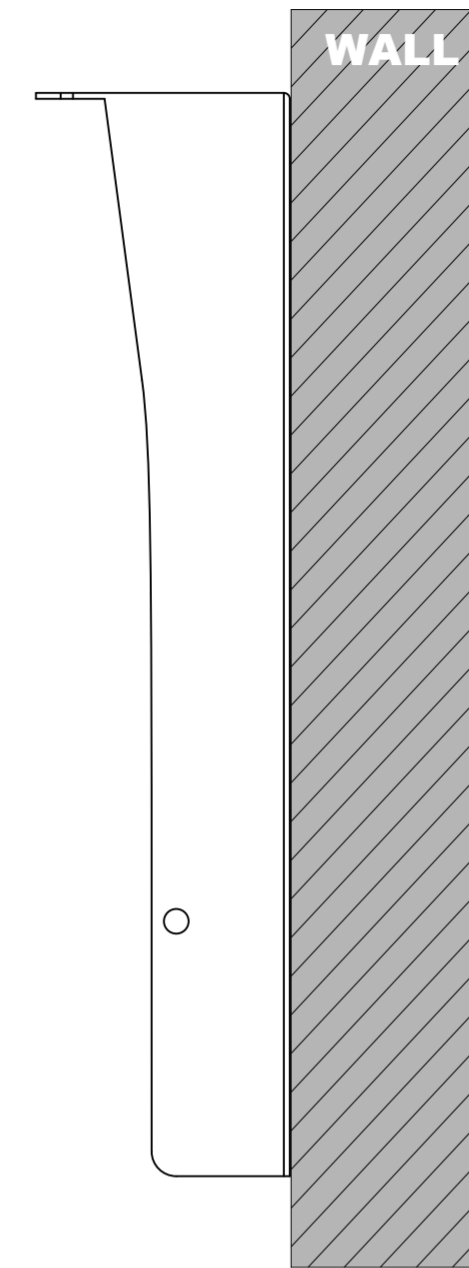

③ SIDE VIEW:INTERCOM IN WALL

Applicable Model

S535

Drawing Title

Thick Wall Mounting
Box

Drawing Unit

mm

Drawing Scale

Not to scale

**DRAFT
SUBJECT TO
CHANGE**

Last Revised

Nov 26, 2025

Drawing Version

V1.1

Page

11 of 20

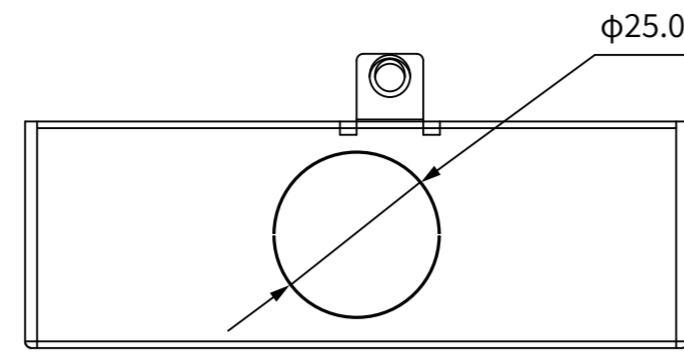

⑥ BOTTOM VIEW

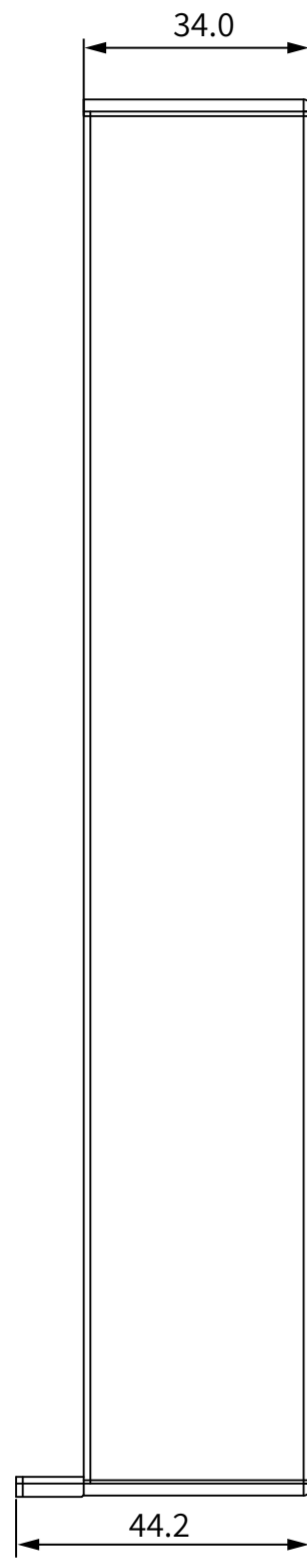

② RIGHT VIEW

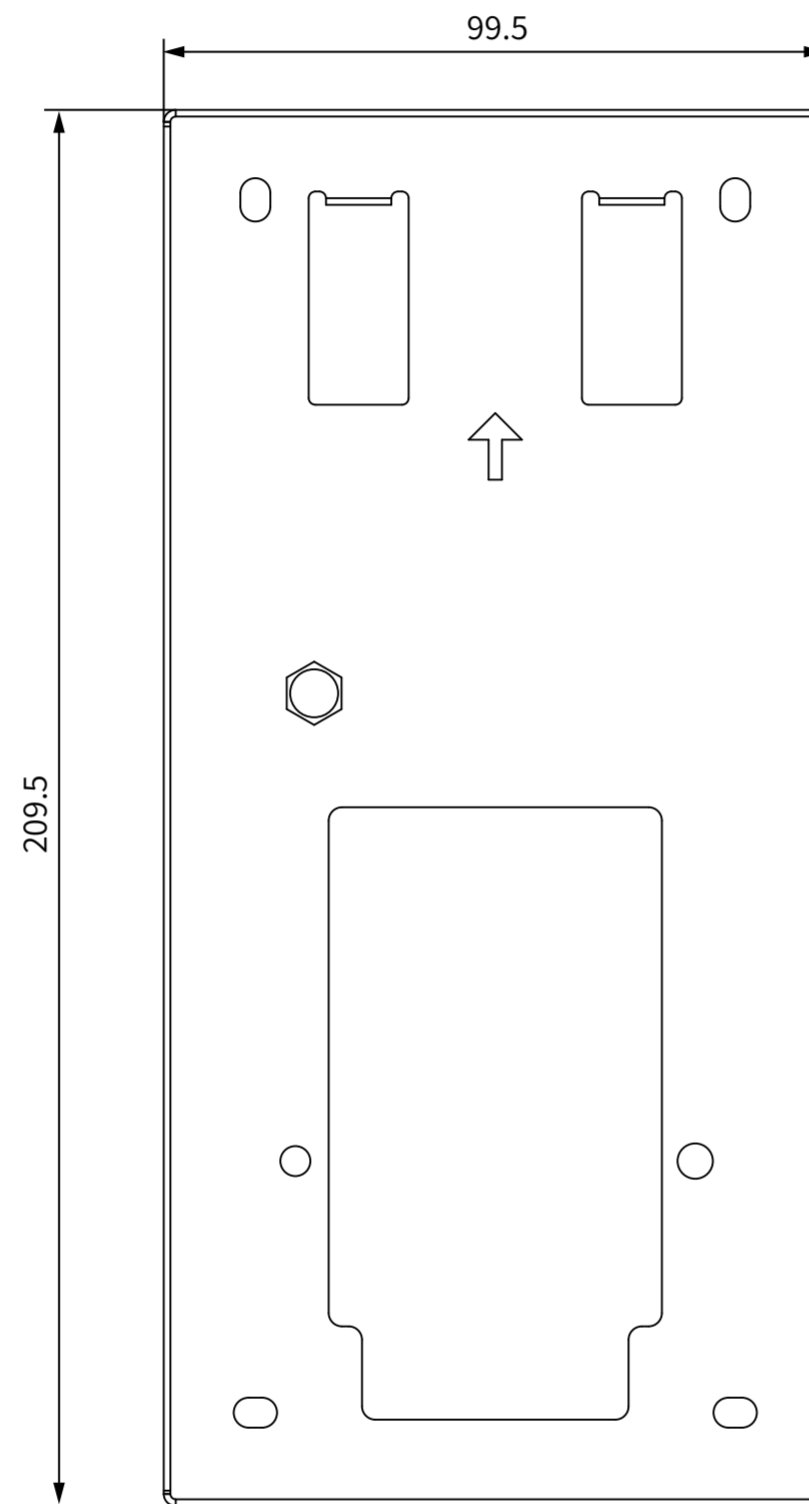

① FRONT VIEW

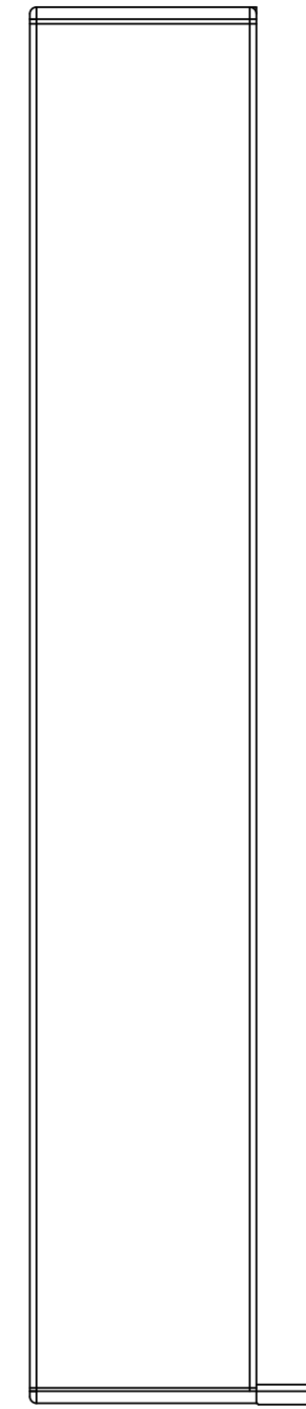

③ LEFT VIEW

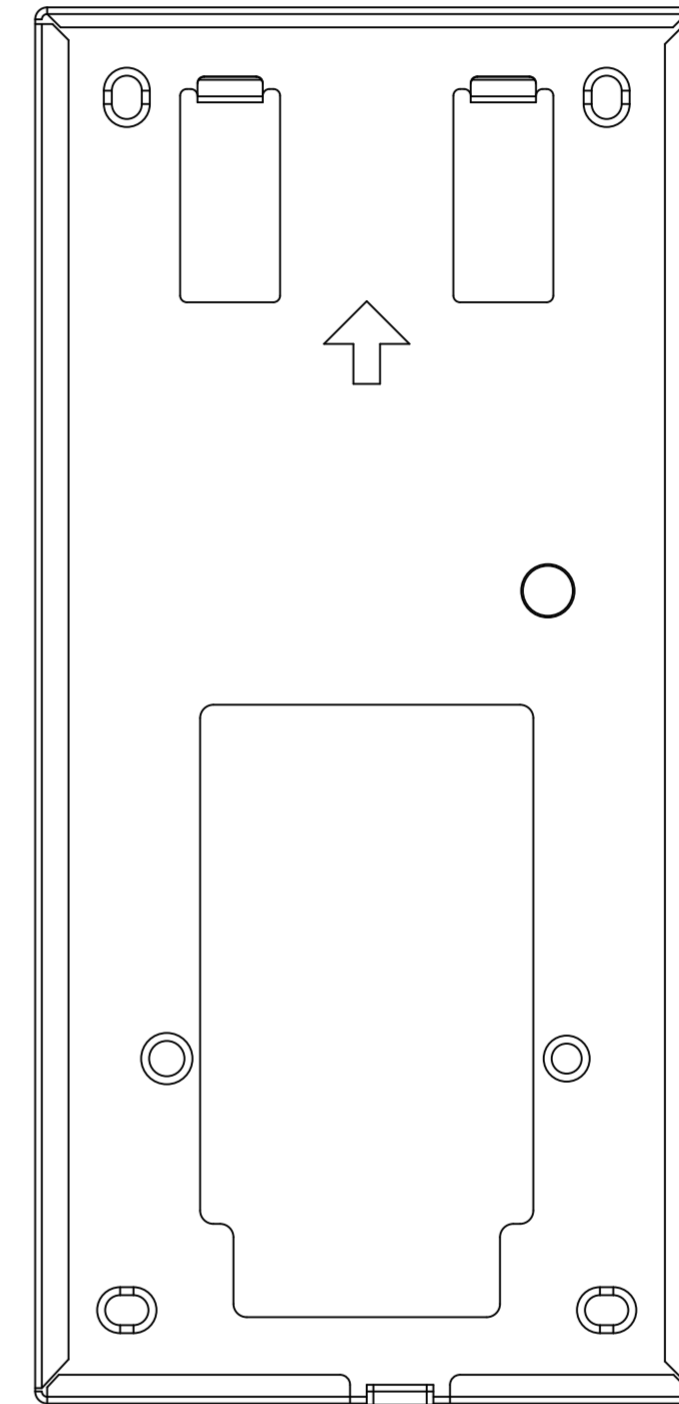

④ BACK VIEW

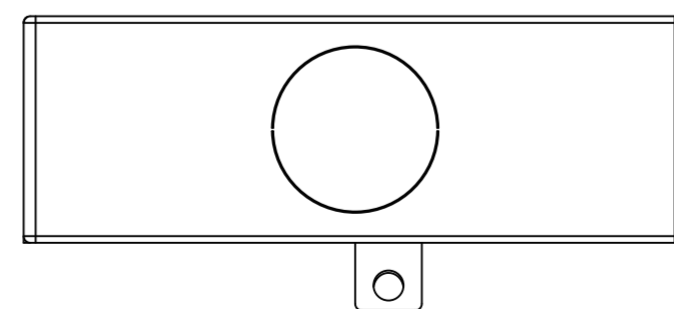

⑤ TOP VIEW

Applicable Model

S535

Drawing Title

Placement

Drawing Unit

mm

Drawing Scale

Not to scale

**DRAFT
SUBJECT TO
CHANGE**

Last Revised

Nov 26, 2025

Drawing Version

V1.1

Page

12 of 20

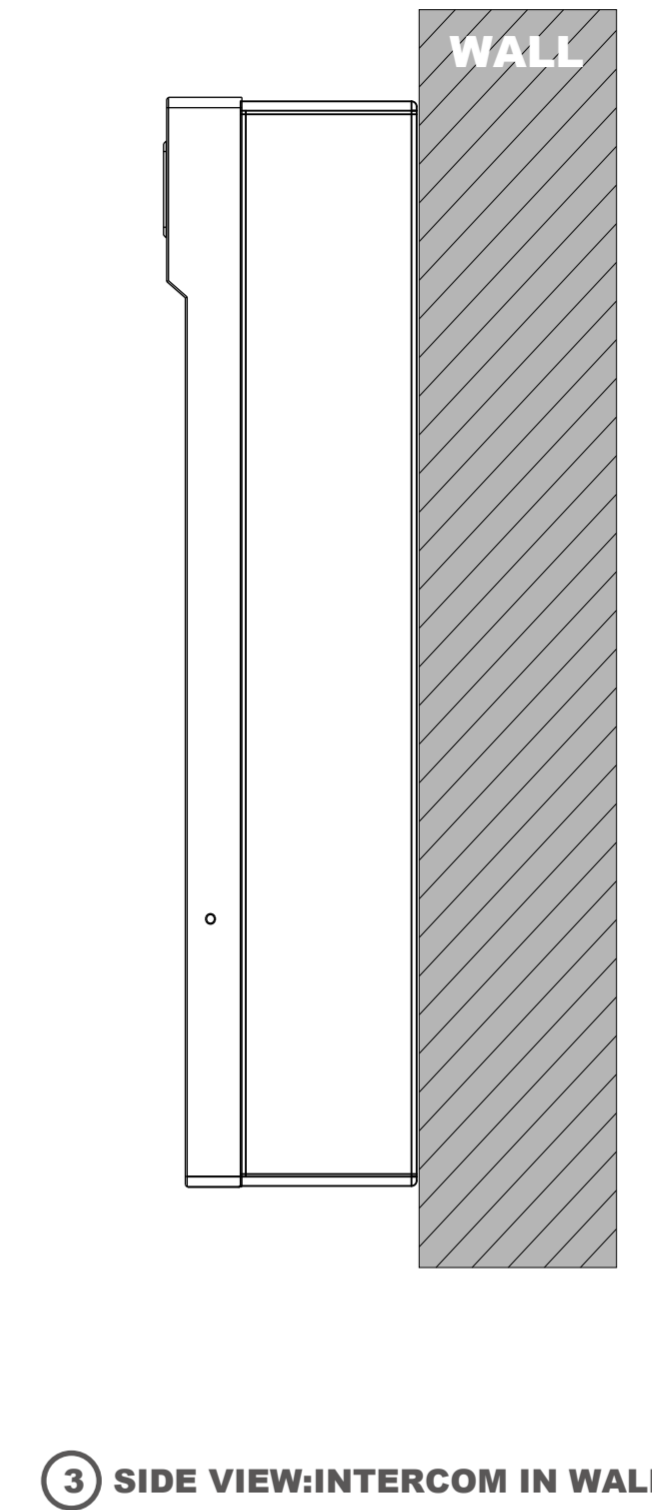
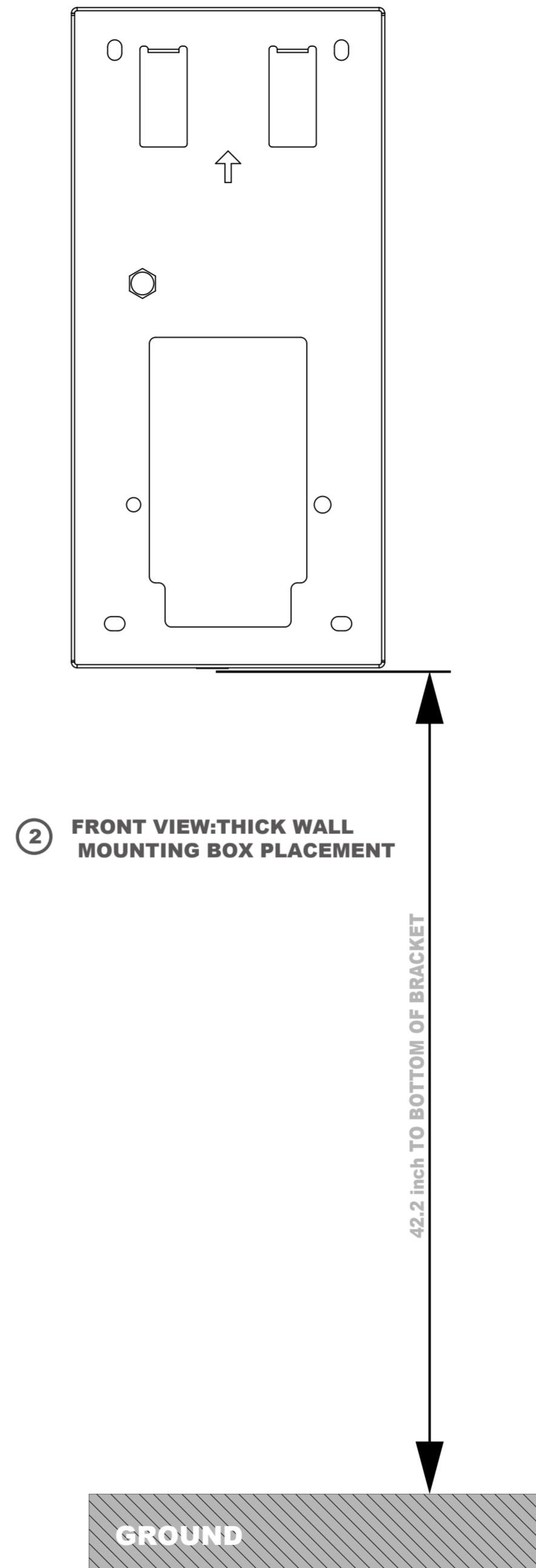
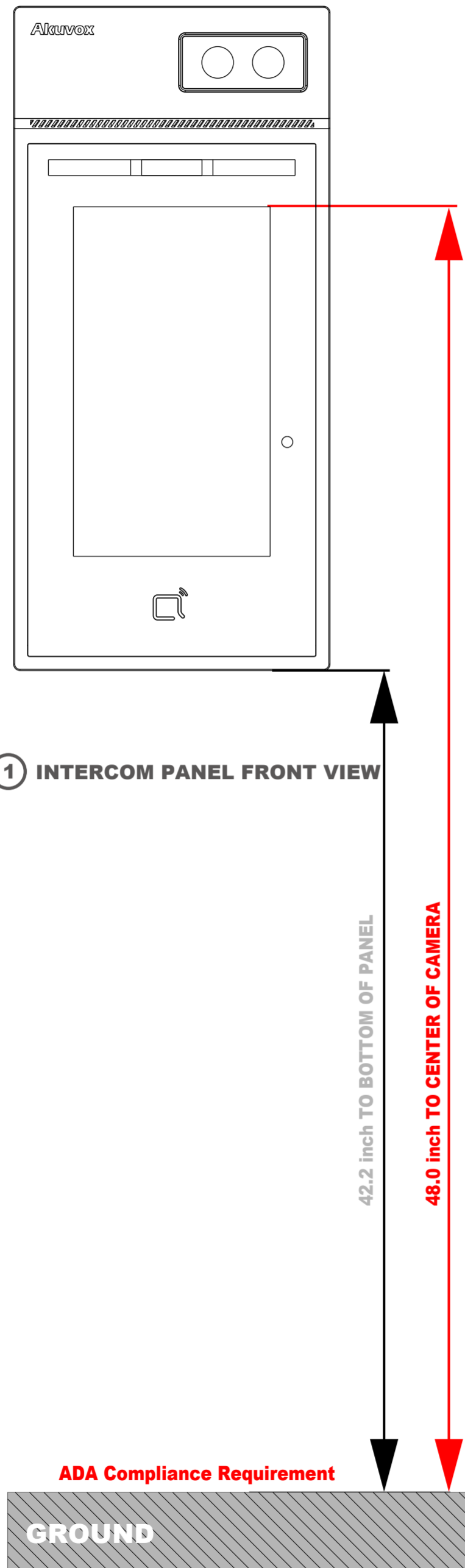

Applicable Model

S535

Drawing Title

Intercom Panel
With Module

Drawing Unit

mm

Drawing Scale

Not to scale

**DRAFT
SUBJECT TO
CHANGE**

Last Revised

Nov 26, 2025

Drawing Version

V1.1

Page

13 of 20

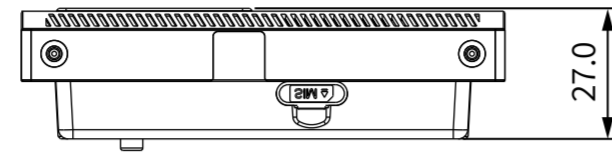

⑥ **BOTTOM VIEW**

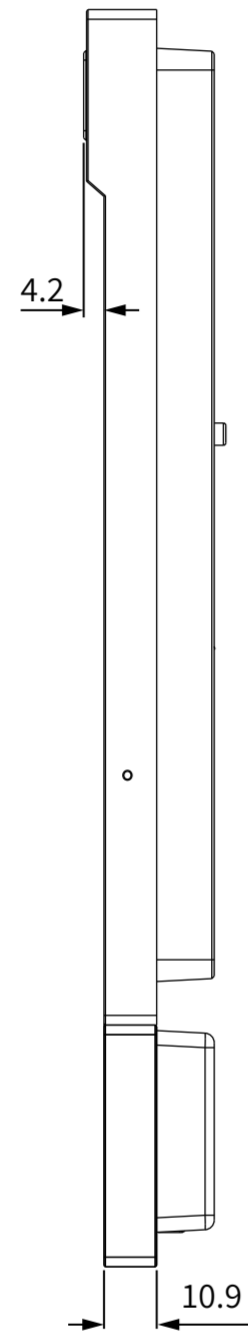

② **RIGHT VIEW**

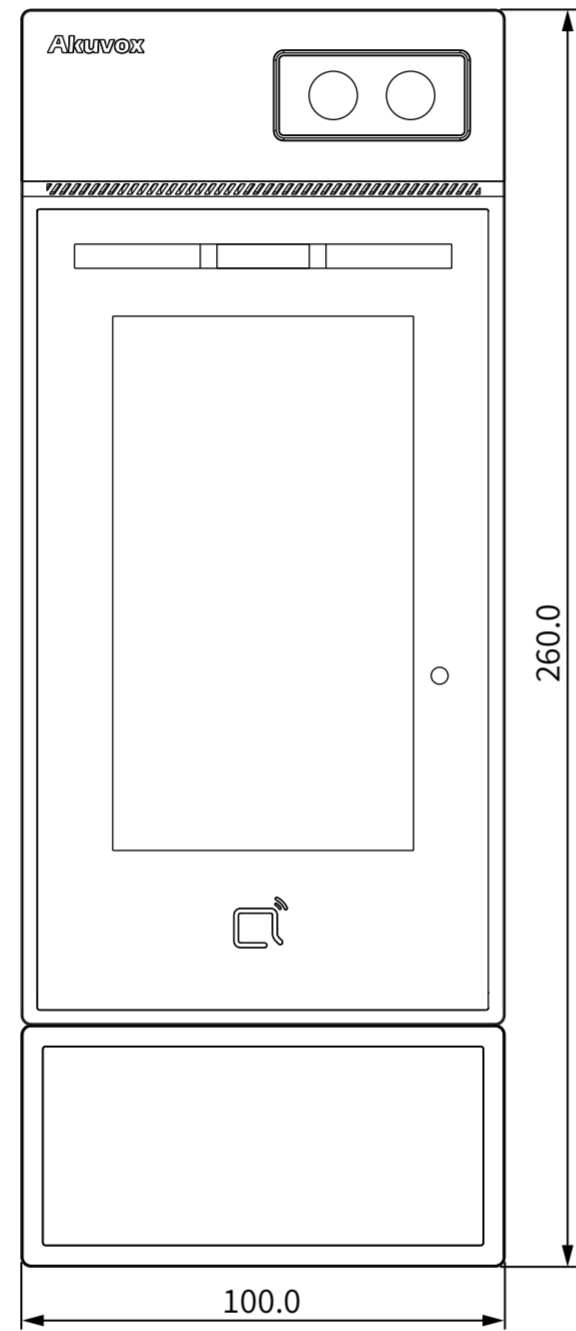

① **FRONT VIEW**

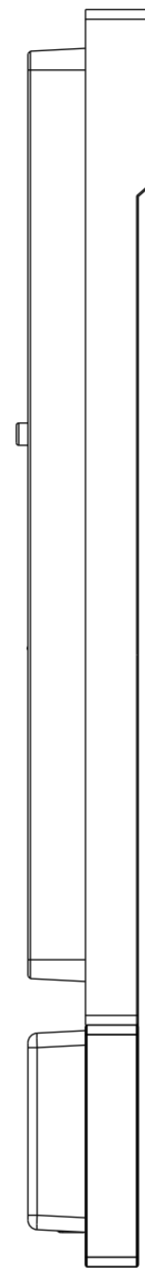

③ **LEFT VIEW**

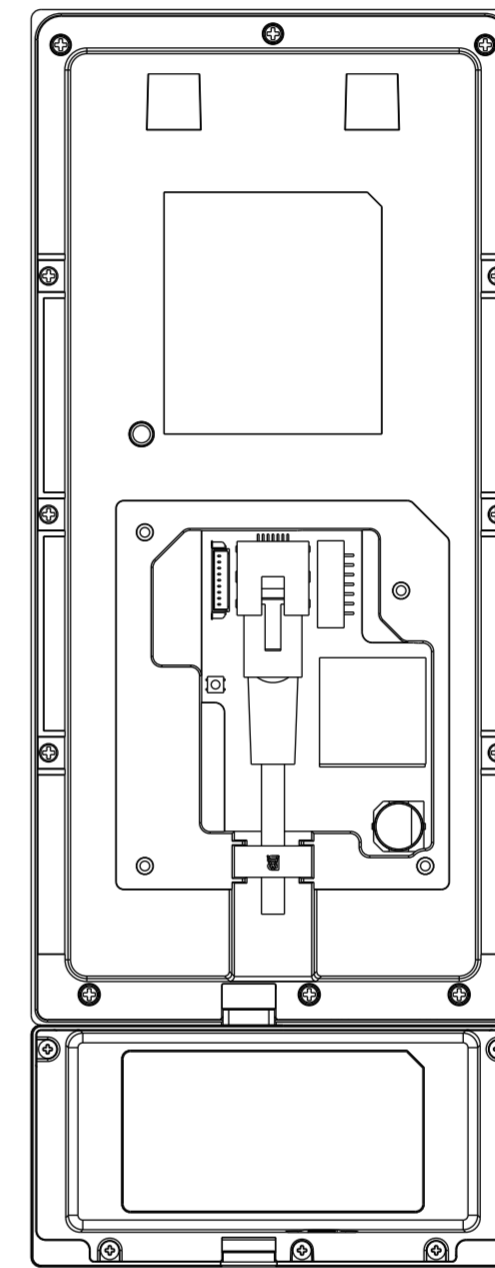

④ **BACK VIEW**

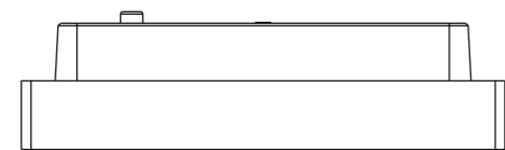

⑤ **TOP VIEW**

Applicable Model

S535

Drawing Title

Wall Mounting
Box With Module

Drawing Unit

mm

Drawing Scale

Not to scale

**DRAFT
SUBJECT TO
CHANGE**

Last Revised

Nov 26, 2025

Drawing Version

V1.1

Page

14 of 20

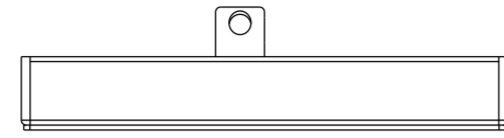

⑥ **BOTTOM VIEW**

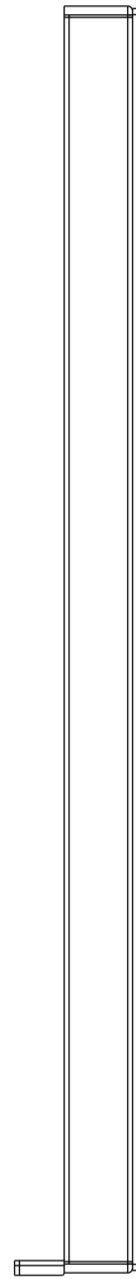

② **RIGHT VIEW**

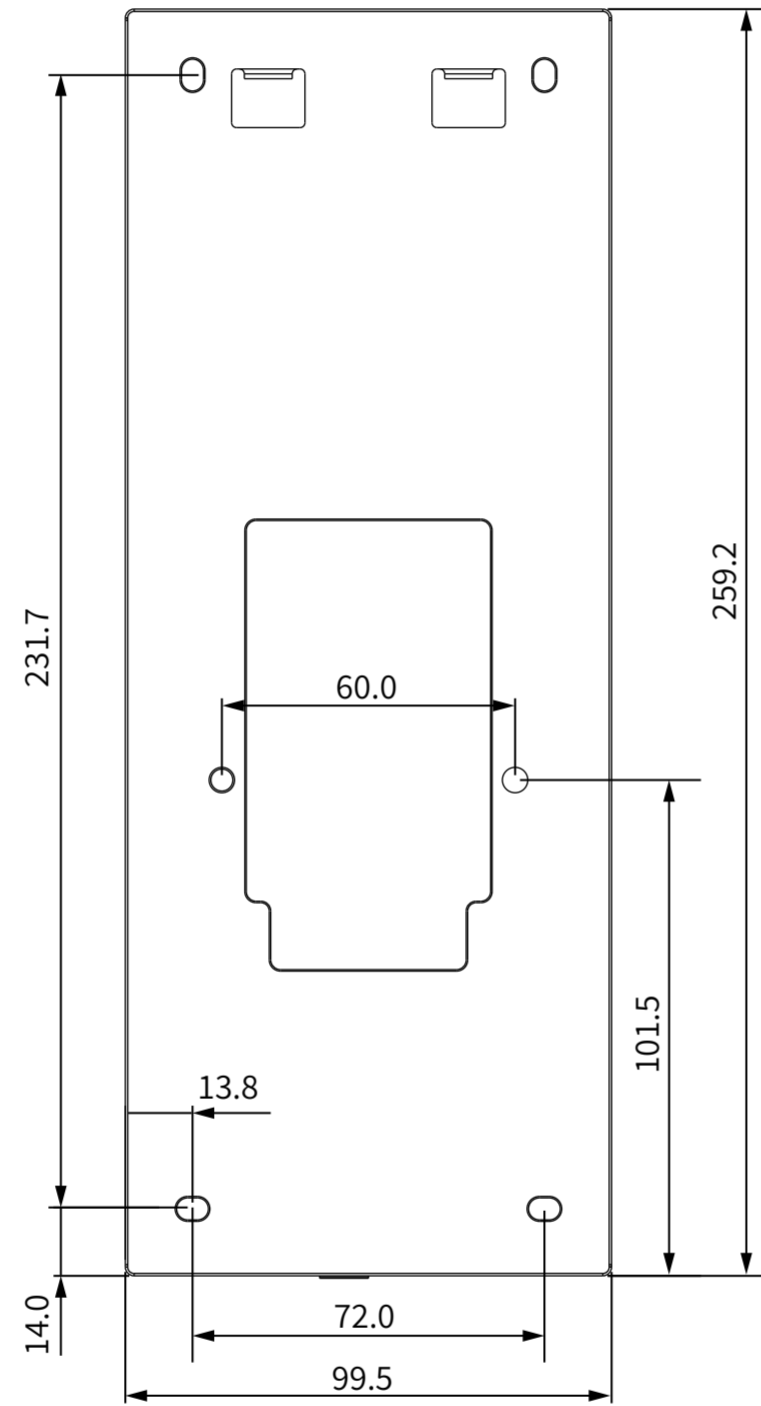

① **FRONT VIEW**

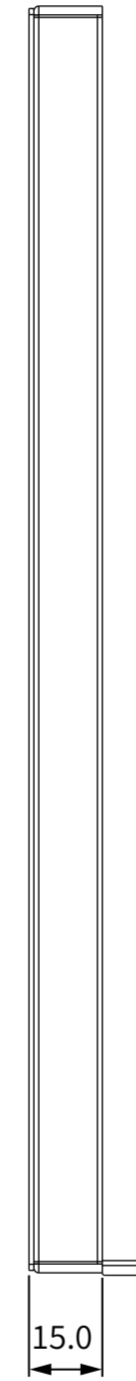

③ **LEFT VIEW**

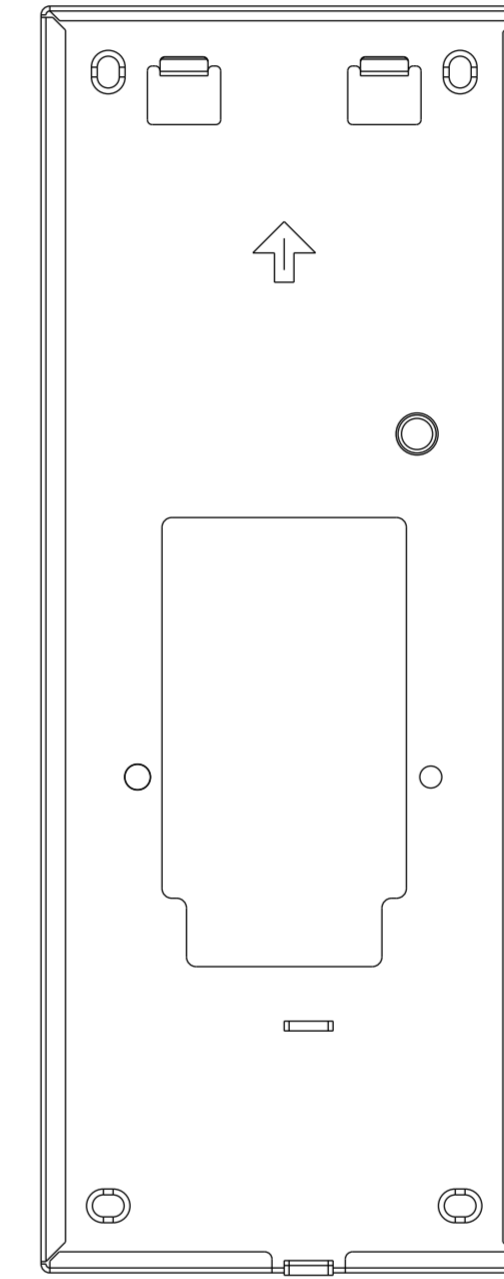

④ **BACK VIEW**

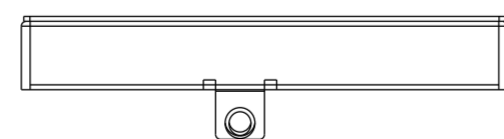

⑤ **TOP VIEW**

Applicable Model

S535

Drawing Title

Placement

Drawing Unit

mm

Drawing Scale

Not to scale

**DRAFT
SUBJECT TO
CHANGE**

Last Revised

Nov 26,2025

Drawing Version

V1.1

Page

15 of 20

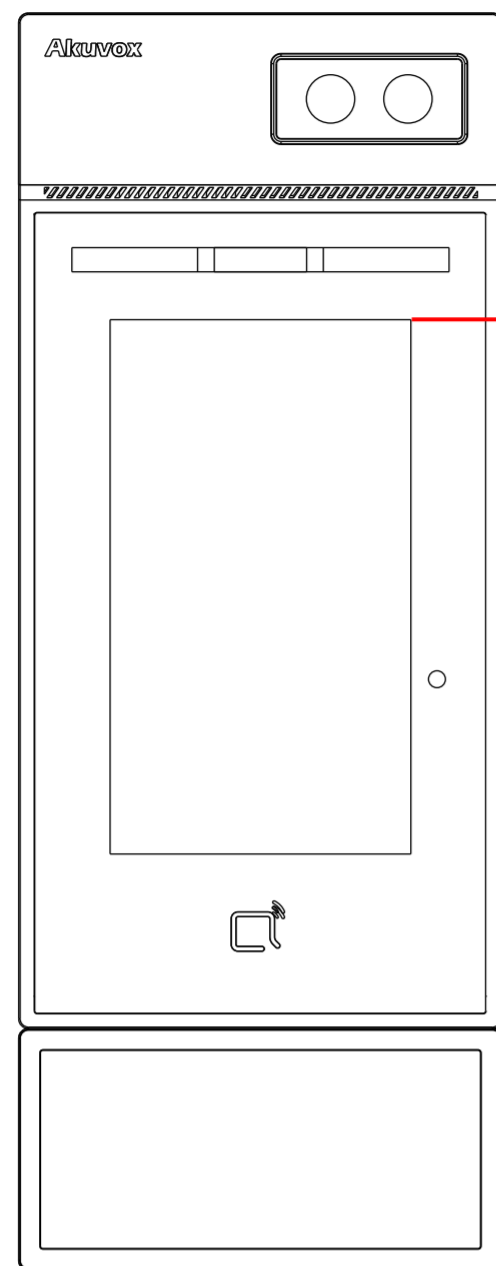

① INTERCOM PANEL FRONT VIEW

40.3 inch TO BOTTOM OF MODULE

48.0 inch TO CENTER OF CAMERA

ADA Compliance Requirement

GROUND

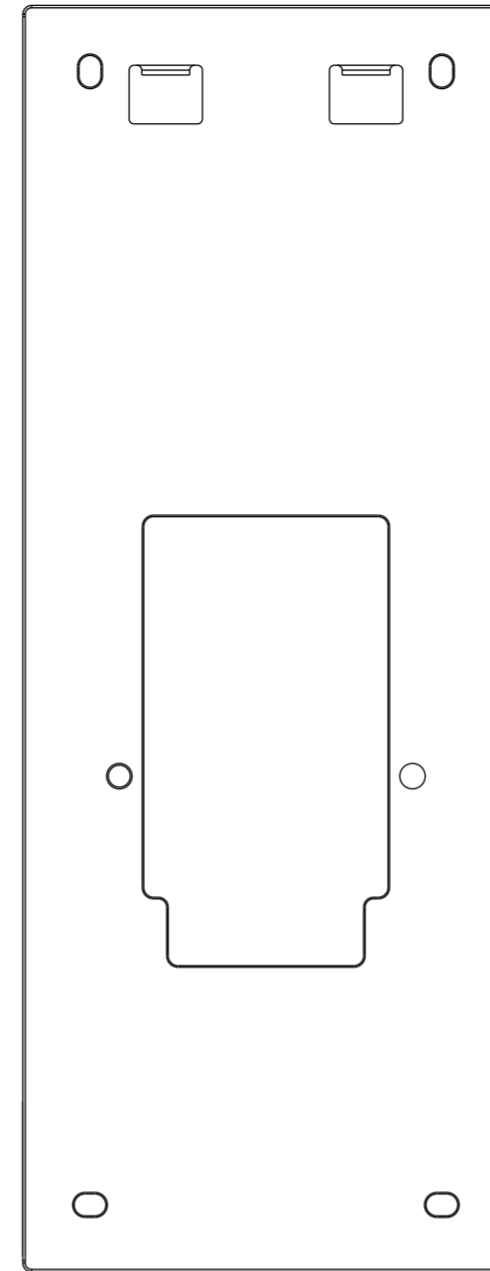

② FRONT VIEW:WALL MOUNTING BOX WITH MODULE PLACEMENT

40.3 inch TO BOTTOM OF MODULE

GROUND

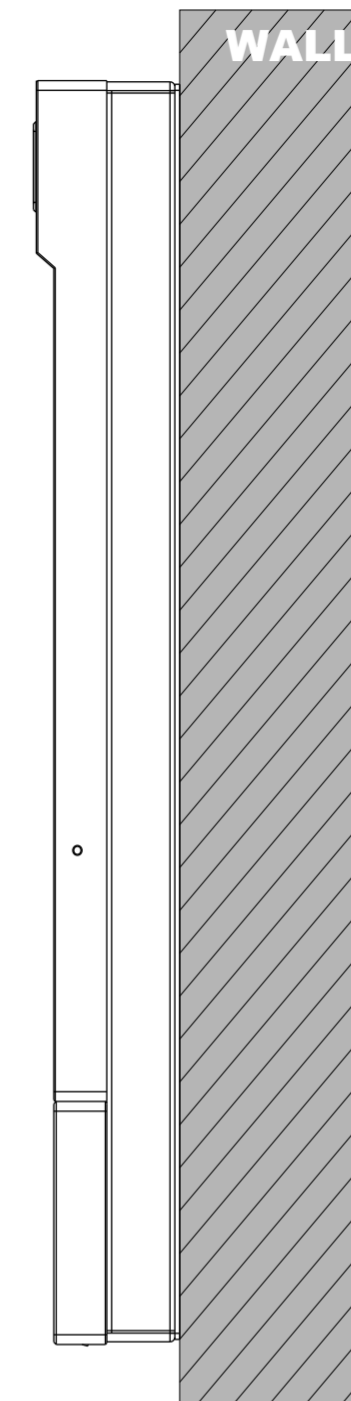

③ SIDE VIEW:INTERCOM ON WALL

Applicable Model

S535

Drawing Title

Flushing Mounting
Bracket With Module

Drawing Unit

mm

Drawing Scale

Not to scale

**DRAFT
SUBJECT TO
CHANGE**

Last Revised

Nov 26, 2025

Drawing Version

V1.1

Page

16 of 20

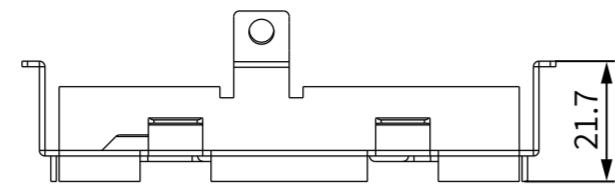

⑥ BOTTOM VIEW

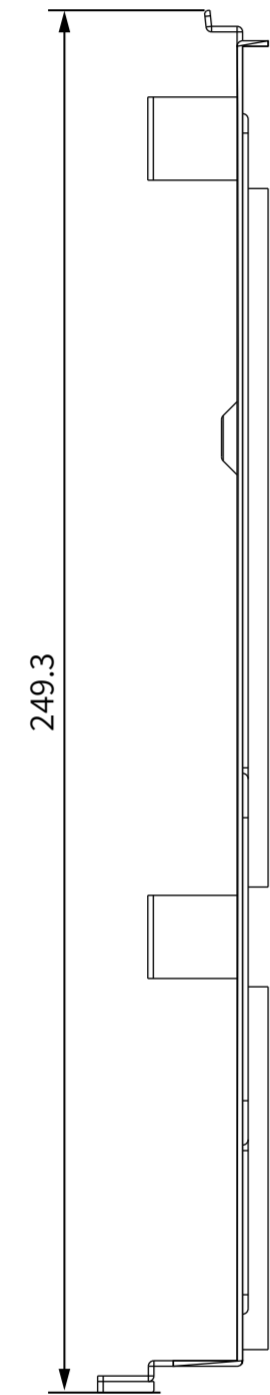

② RIGHT VIEW

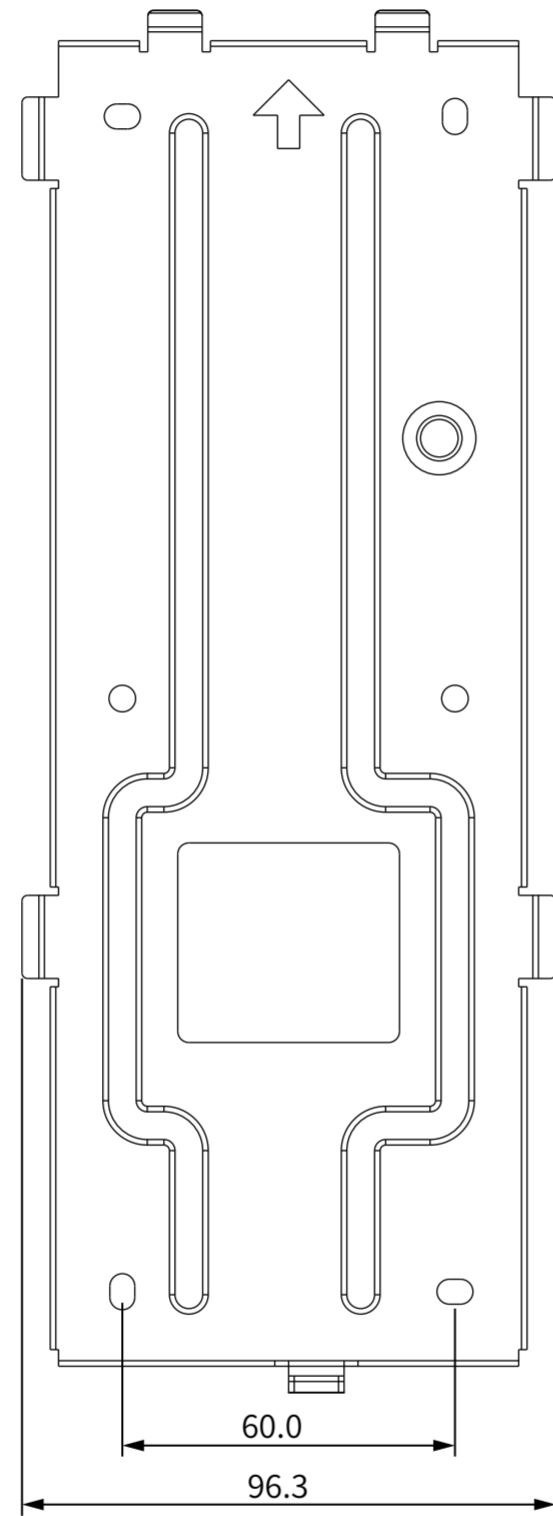

① FRONT VIEW



③ LEFT VIEW

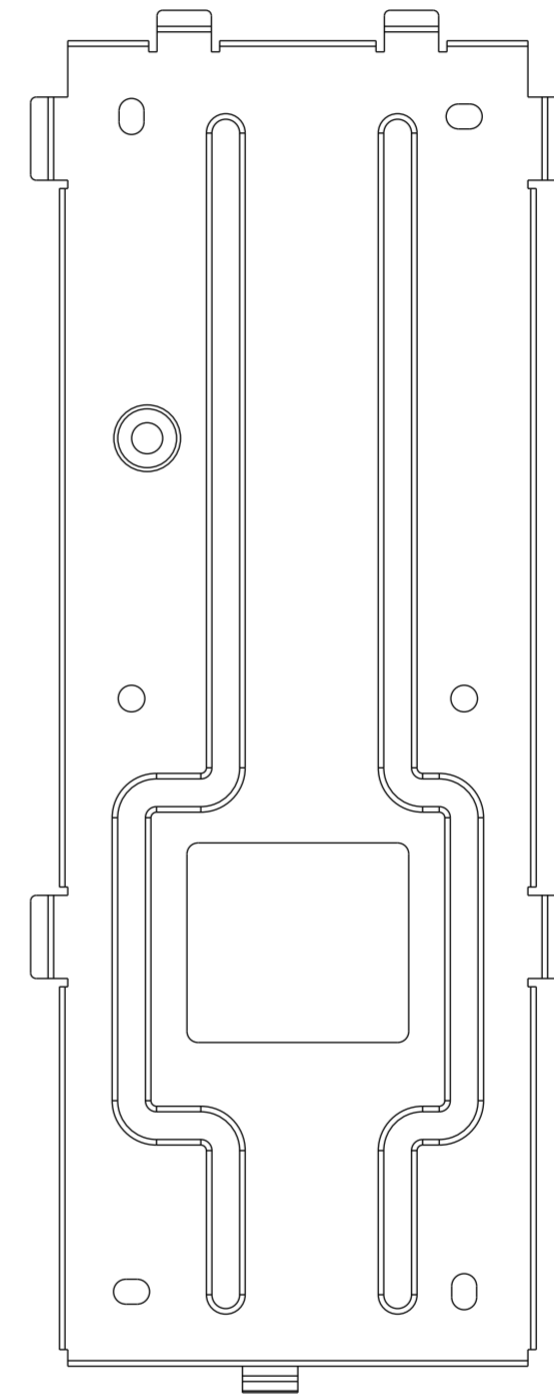

④ BACK VIEW

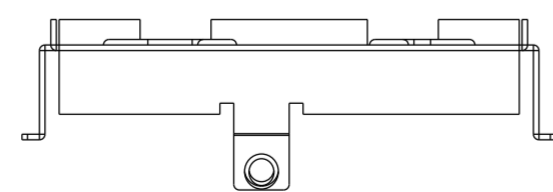

⑤ TOP VIEW

Applicable Model

S535

Drawing Title

Flushing Mounting
Box With Module

Drawing Unit

mm

Drawing Scale

Not to scale

**DRAFT
SUBJECT TO
CHANGE**

Last Revised

Nov 26, 2025

Drawing Version

V1.1

Page

17 of 20

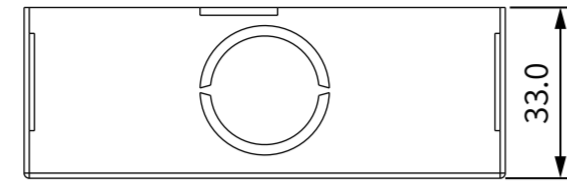

⑥ BOTTOM VIEW

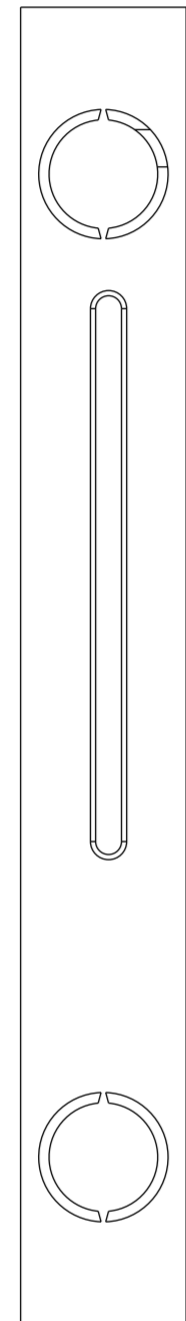

② RIGHT VIEW

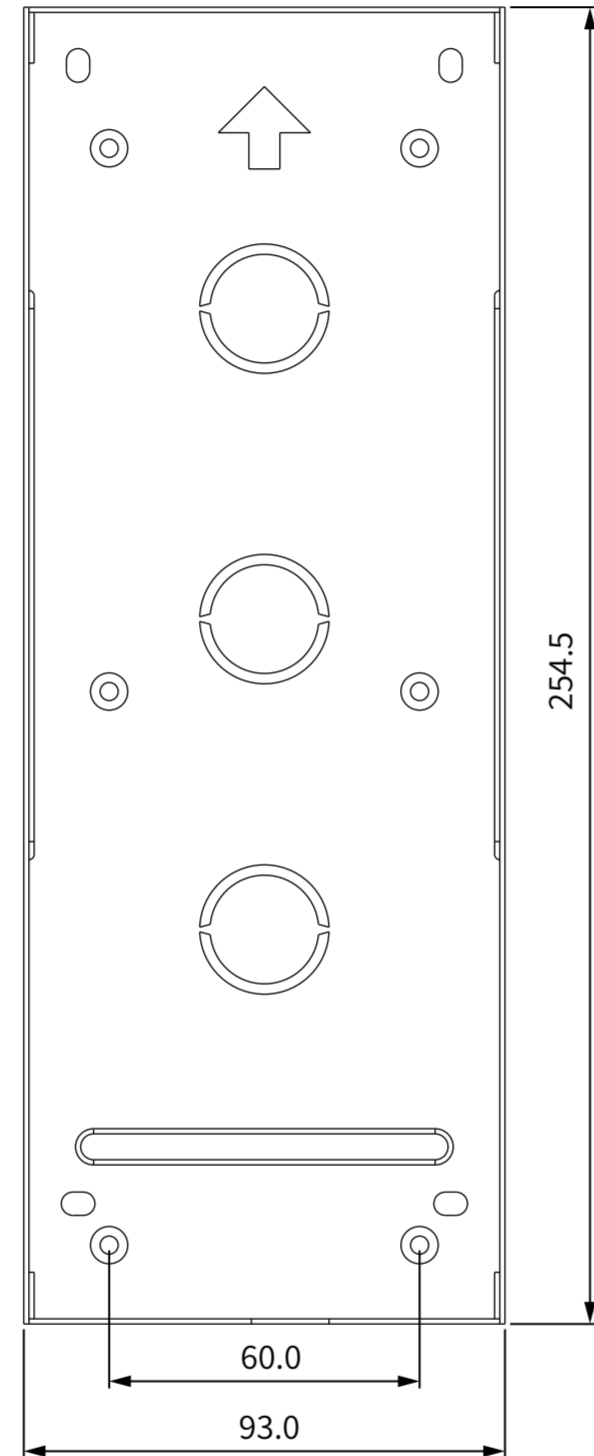

① FRONT VIEW

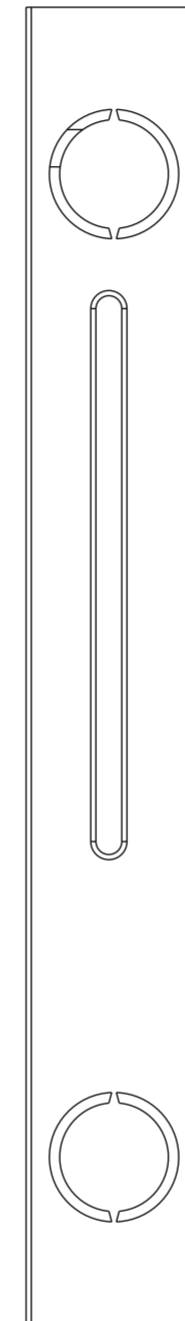

③ LEFT VIEW

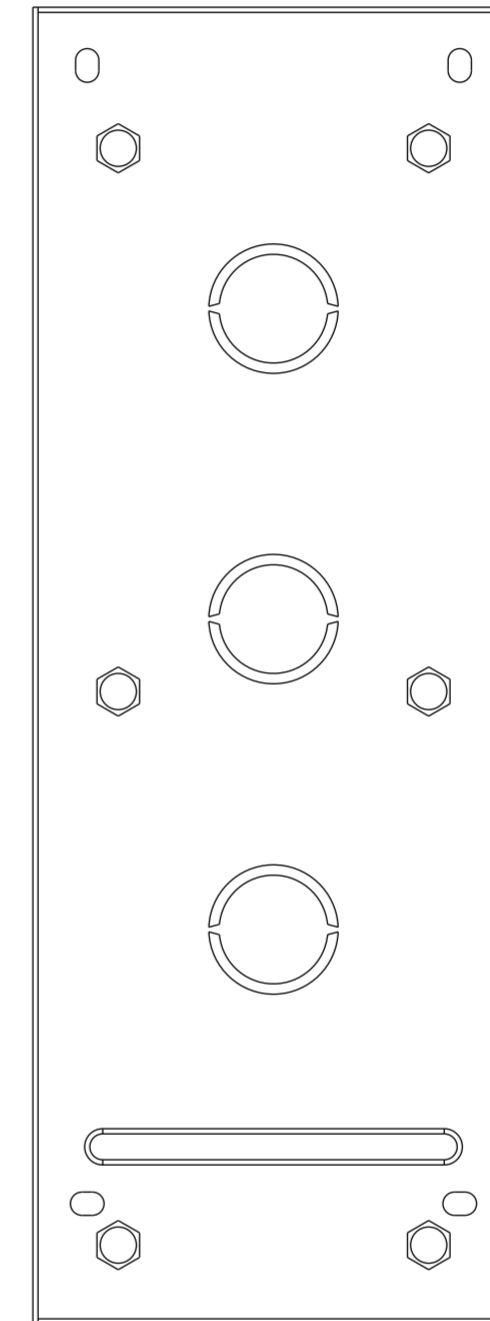

④ BACK VIEW

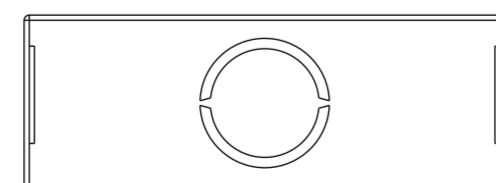

⑤ TOP VIEW

Applicable Model
S535

Drawing Title
Placement

Drawing Unit
mm

Drawing Scale
Not to scale

DRAFT
SUBJECT TO
CHANGE

Last Revised
Nov 26, 2025

Drawing Version
V1.1

Page
18 of 20

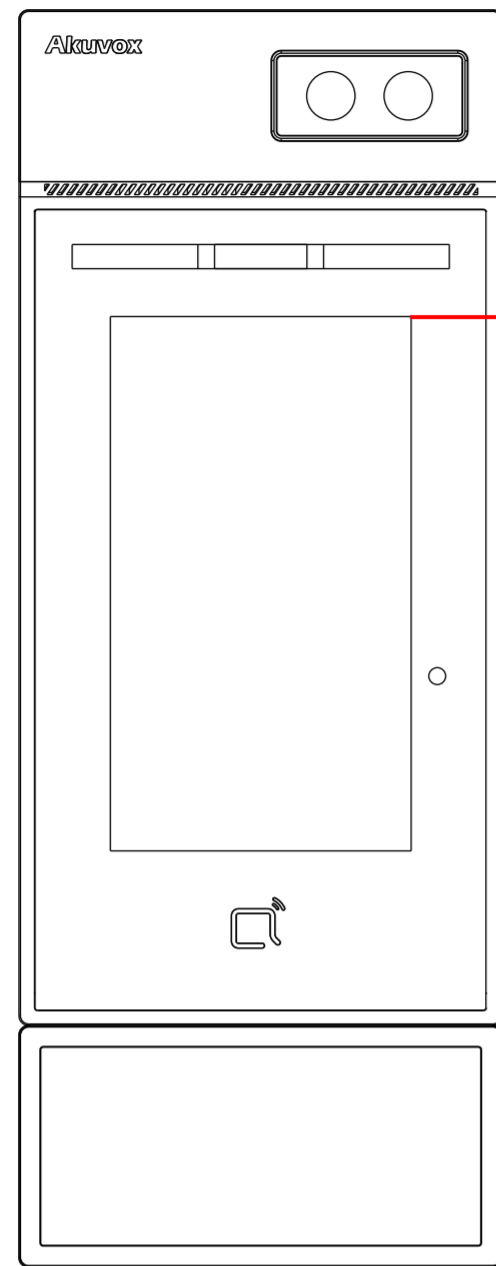

① INTERCOM PANEL FRONT VIEW

40.3 inch TO BOTTOM OF MODULE

48.0 inch TO CENTER OF CAMERA

ADA Compliance Requirement

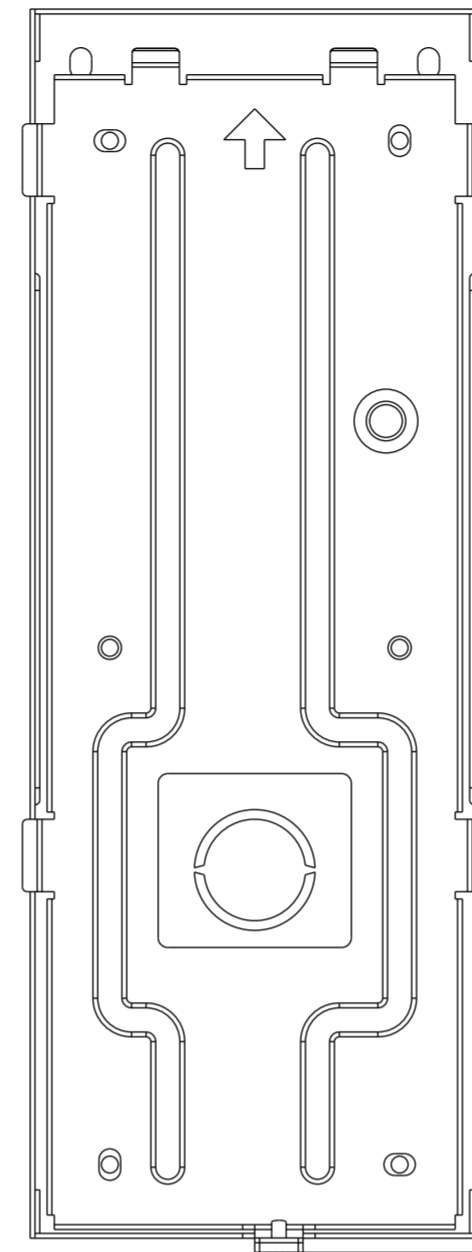
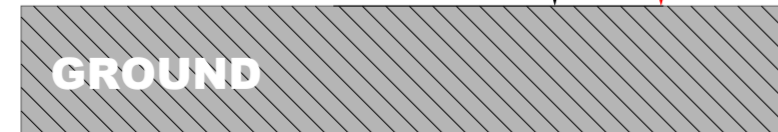

② FRONT VIEW:FLUSHING MOUNTING BOX WITH MODULE PLACEMENT

40.3 inch TO BOTTOM OF MODULE

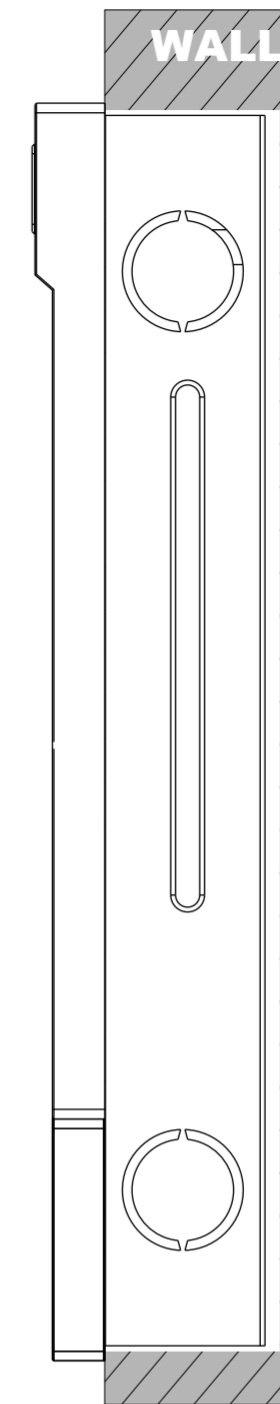

③ SIDE VIEW:INTERCOM IN WALL

Applicable Model

S535

Drawing Title

Thick Wall Mounting
Box With Module

Drawing Unit

mm

Drawing Scale

Not to scale

**DRAFT
SUBJECT TO
CHANGE**

Last Revised

Nov 26, 2025

Drawing Version

V1.1

Page

19 of 20

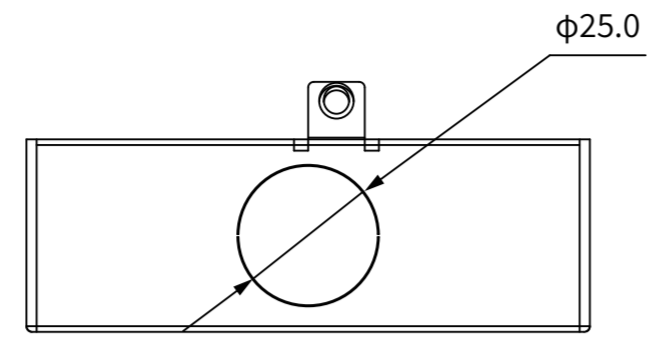

6 BOTTOM VIEW

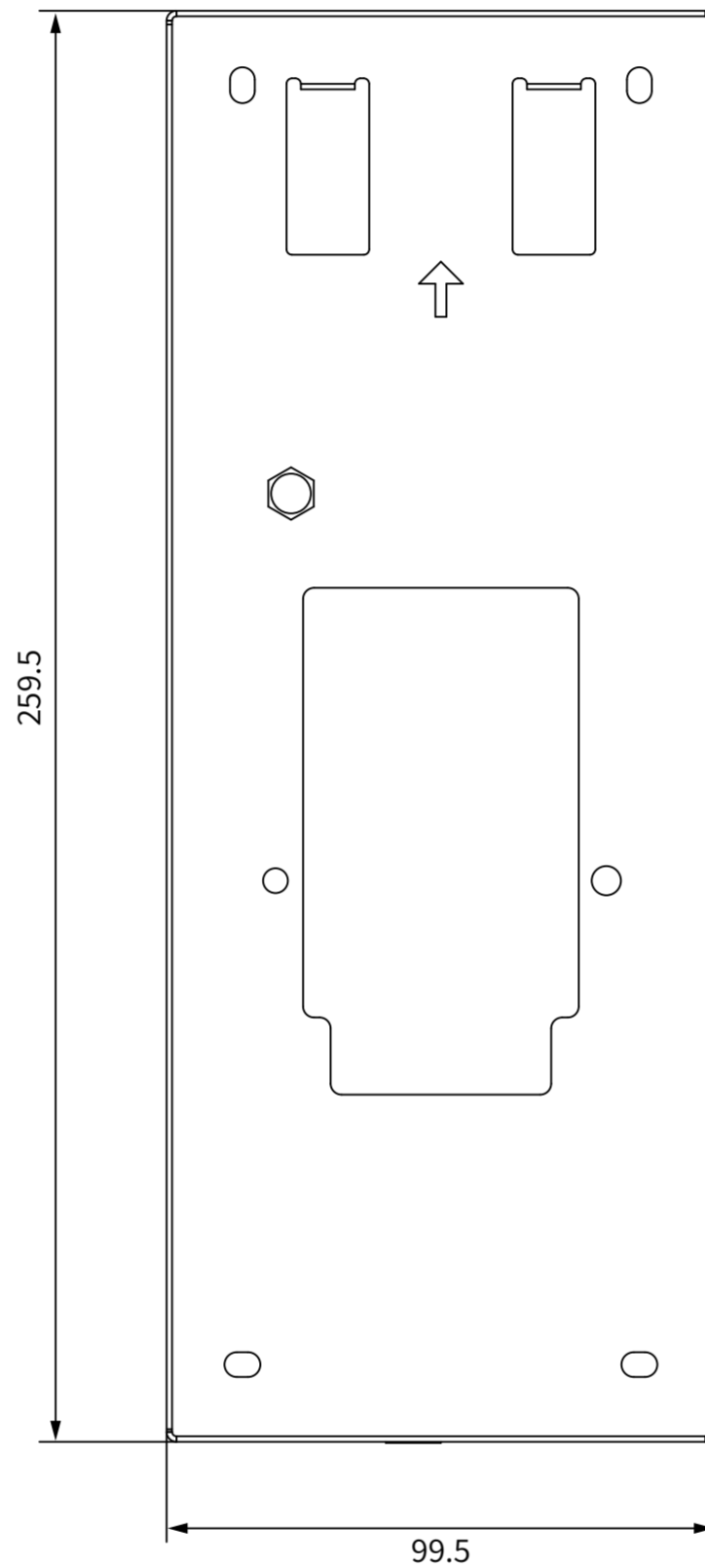

1 FRONT VIEW

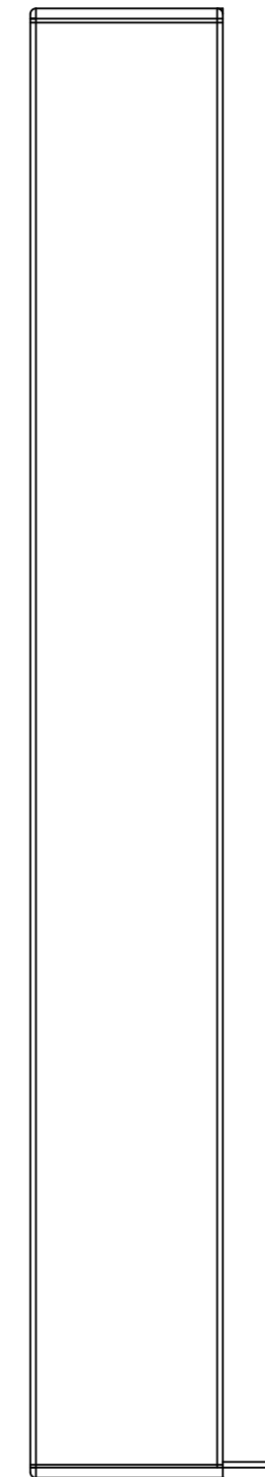

3 LEFT VIEW

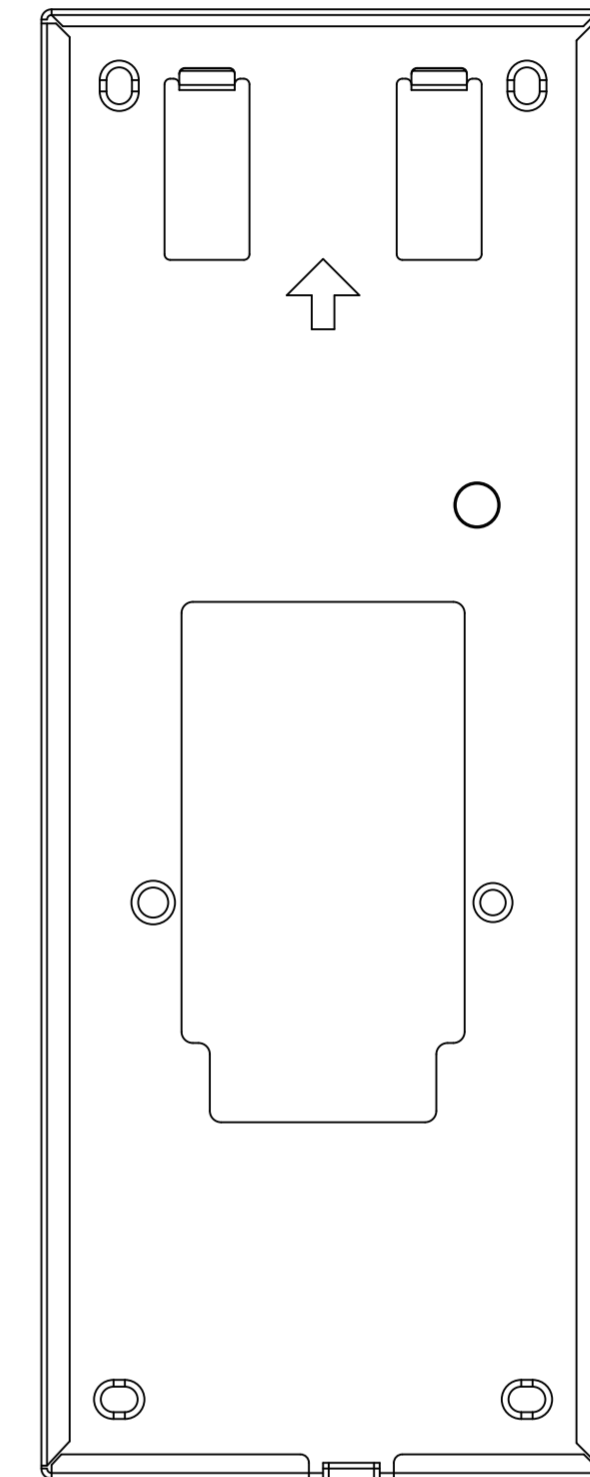

4 BACK VIEW

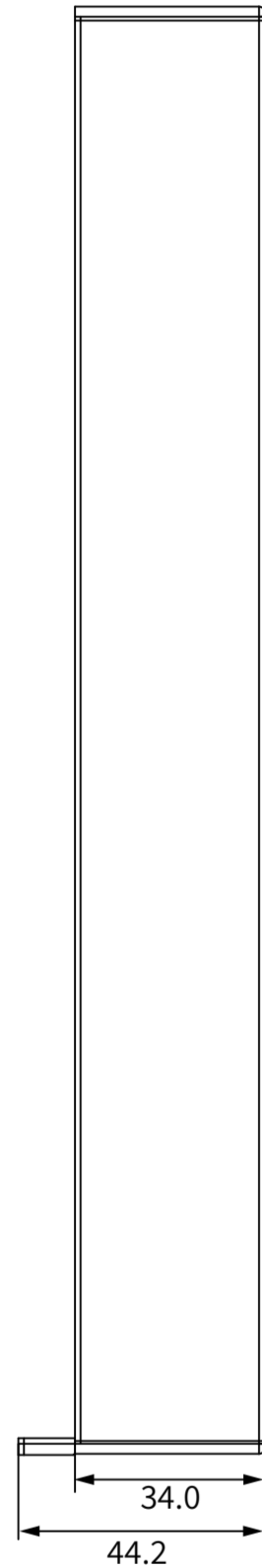

2 RIGHT VIEW

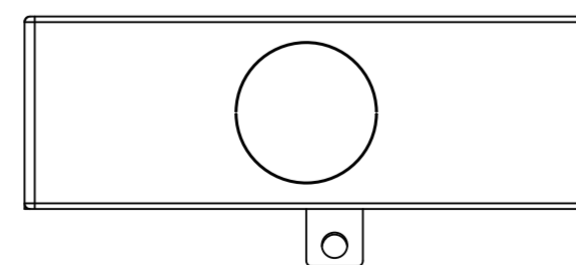

5 TOP VIEW

Applicable Model

S535

Drawing Title

Placement

Drawing Unit

mm

Drawing Scale

Not to scale

**DRAFT
SUBJECT TO
CHANGE**

Last Revised

Nov 26, 2025

Drawing Version

V1.1

Page

20 of 20

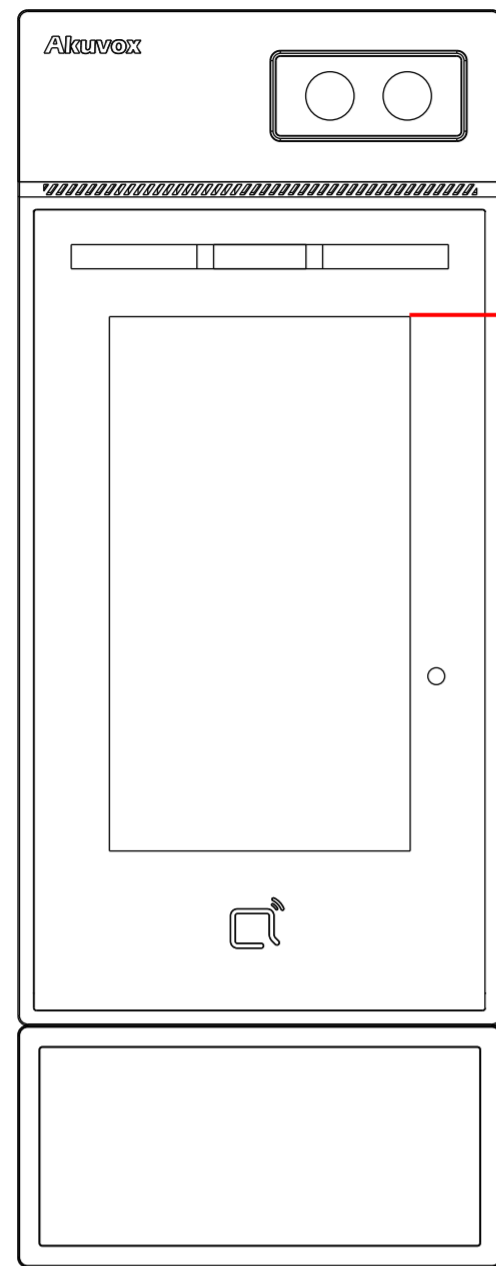

① INTERCOM PANEL FRONT VIEW

40.3 inch TO BOTTOM OF MODULE

48.0 inch TO CENTER OF CAMERA

ADA Compliance Requirement

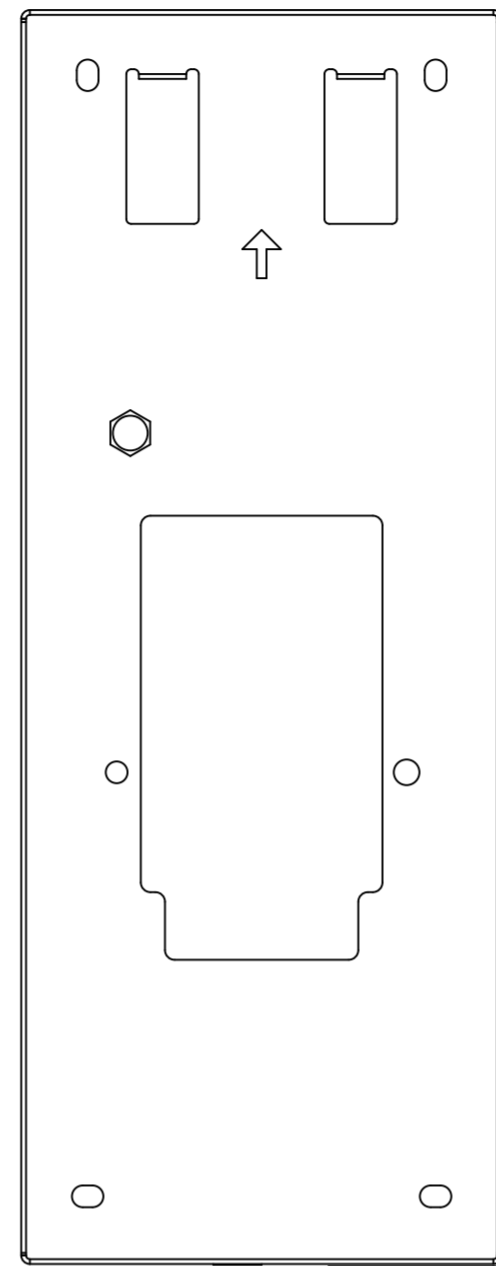
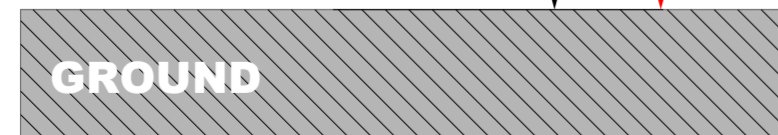

② FRONT VIEW:THICK WALL MOUNTING BOX WITH MODULE PLACEMENT

40.3 inch TO BOTTOM OF MODULE

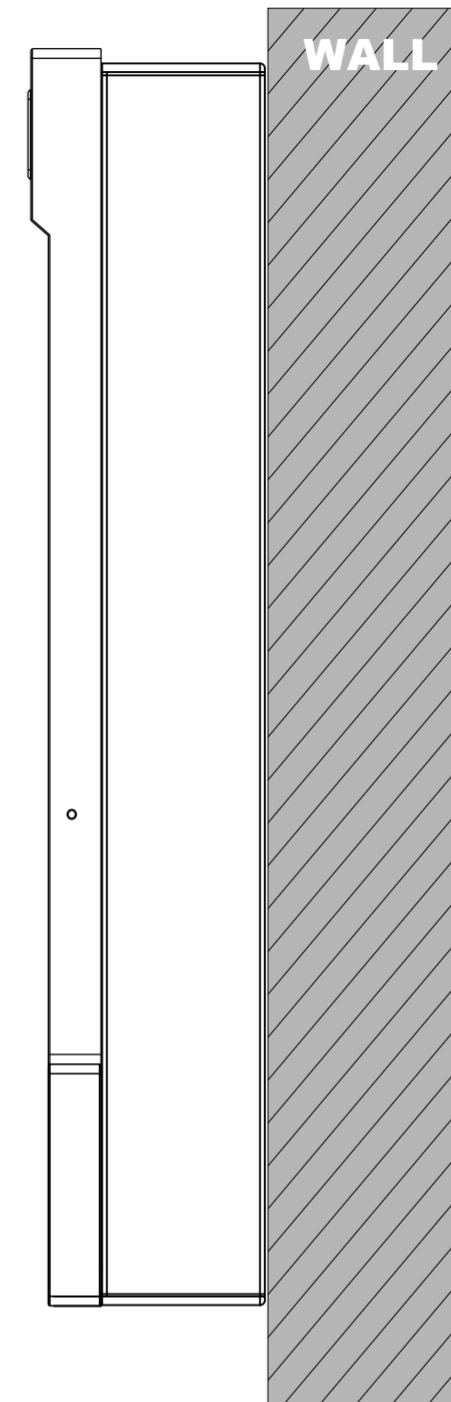

③ SIDE VIEW:INTERCOM IN WALL